

# SOLAR PRODUCTS





## SOLARPAK SELECTOR

Franklin's user-friendly SolarPAK Selector helps you determine the optimal system for your solar project. Simply input your location, duty requirements, and solar panel characteristics (if known) and the system will automatically recommend the model and array configuration best for your application.

### FE SELECT SolarPAK

Selection Criteria    Decimal    Standard US    Language

**APPLICATION**    Submersible

**BASIC OPERATING CONDITIONS**

Total Dynamic Head: 0.00 ft  
Solve To: Flow  
Flow: 0.00 USgpm  
Thread Type: Auto by location  
Catalog Region: Auto by Location

\*Maximum allowable water temperature of 86F/30C. Consult factory for higher temperature ratings.

**LOCATION**    Lookup

Degrees Latitude: 41  
Degrees Longitude: -85  
City/State:  
Country:

**SOLAR PANEL CHARACTERISTICS**

Performance Data Type: STC  
Watts (Wmpp): 0.0 W  
Volts (Vmpp): 0.0 V  
Volts (Voc): 0.0 V  
Use Solar Tracker Array:   
Peak Month For Sizing: Annual Average

**WIRE\***

Length: 0.00 ft  
Material Type: AWG/MM Copper  
Insulation Temperature: 75°C

\*Wire sizing and wire lengths must conform to local, national or government electrical wiring standards and regulations.

Search

Solar Irradiation for : 4.95 Solar Hours

Month	Average Monthly Solar Irradiation (Hours)
Jan	3.89
Feb	4.52
Mar	5.21
Apr	5.32
May	5.69
Jun	5.86
Jul	5.93
Aug	5.37
Sep	6.00
Oct	4.67
Nov	3.73
Dec	3.25

\*Above screen shot is illustrative only and is subject to continuous improvement

The Franklin Electric Photon™ SolarPAK Selector and other information on our series of solar products can be found at:

[franklinwater.com/solar](http://franklinwater.com/solar)

## SOLAR PRODUCTS

<b>SubDrive SolarPAK (3/4–3 hp, 0.55–2.2 kW)</b> .....	<b>2</b>
Ordering Information .....	4
0.75 HP (0.55 kW) Performance .....	5
1.5 HP (1.1 kW) Performance.....	9
3.0 HP (2.2 kW) Performance .....	17
Dimensions.....	24
Drive Specifications .....	25
<b>Fhoton™ SolarPAK (1/2–1.5 hp, 0.37–1.1 kW)</b> .....	<b>26</b>
Ordering Information .....	29
0.5 HP (0.37 kW) Performance .....	30
0.75 HP (0.55 kW) Performance .....	34
1.5 HP (1.1 kW) Performance.....	40
Dimensions.....	48
Drive Specifications .....	49
<b>Fhoton™ SolarPAK (5–10 hp, 3.7–7.5 kW)</b> .....	<b>50</b>
Ordering Information .....	52
5.0 HP (3.7 kW) Performance.....	53
7.5 HP (5.5 kW) Performance .....	68
10 HP (7.5 kW) Performance .....	82
Dimensions.....	96
Drive Specifications .....	97
<b>Fhoton™ Surface SolarPAK (1/2–1.5 hp, 0.37–1.1 kW)</b> .....	<b>98</b>
Ordering Information .....	98
0.5–1.5 HP Performance .....	99
Dimensions.....	103
<b>Accessories</b> .....	<b>104</b>
<b>Installation Quick Reference</b> .....	<b>106</b>

For the most up-to-date product information, visit [franklinwater.com](http://franklinwater.com).

## SUBDRIVE SOLARPAK (3/4–3 HP, 0.55–2.2 KW)

The SubDrive SolarPAK is the System Solution to your solar pumping requirements. Using Franklin quality components, our technical expertise in groundwater pumping, and innovative thinking based on global market inputs, we have developed a rugged, high-output system which tackles the challenges of remote and harsh environments. No other system delivers the features, benefits, and reliability of SubDrive SolarPAK in just one package!

### FEATURES

- High flow system for faster tank fill and significant water output
- Proven motor and pump technology for long-term reliability
- Robust IP55, NEMA 3 drive enclosure minimizes impact of wildlife, insects, dust, and weather
- DC and AC power inputs with auto-switching between the solar array and an AC backup source
- Seven segment controller display shows real-time input watts and system status
- Remote telemetry capability through a RS-485 continuous data port
- MPPT – Max Power Point Tracking for maximizing efficiency of input power
- Soft start feature prevents water hammer and increases system life
- Simple installation and no required maintenance
- Built-in diagnostics and protection
- C-tick and cULus approved



### SOLARPAK CONTENTS

- Franklin Electric 4" submersible motor
- Franklin Electric 4" submersible pump
- SubDrive solar controller
- Flow switch with 30 ft (10 m) cable
- Variety of flow rates available: 5, 7, 10, 15, 25, 35, 45 or 90 US gpm (18, 25, 30, 45, 70, 100, 150 or 270 lpm)
- Motor and drive ratings available: 0.75, 1.5 or 3.0 hp (0.55, 1.1 or 2.2 kW)

### SOLARPAK NOMENCLATURE

**XXX SD SP - X.XHP**

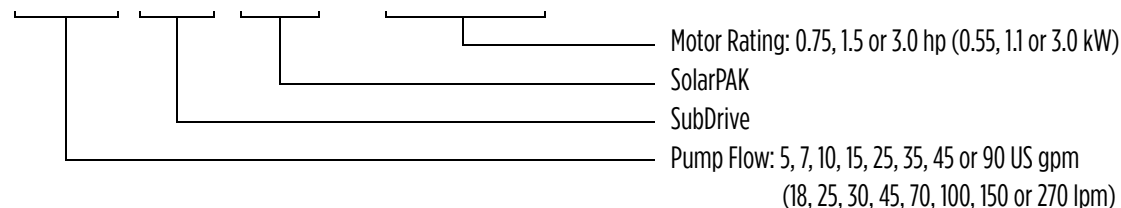

## SUBDRIVE SOLARPAK

### COMPONENTS

Continuous data connection for remote telemetry made available via a RS-485 port.

IP55, NEMA 3 rated enclosure for outdoor use.

DC and AC power supply input. Automatic switching to AC generator backup power if no DC is available from the solar array.

Contacts for up to two level-control switches (can also operate from a pressure switch, used for long pipe runs).

TRIP contact for flow switch to detect dry run conditions and protect the motor.



Easy to read, 3 digit, 7 segment LED display. Provides ease of programming and troubleshooting.

Push button navigation for ease of programming and display control.

Sliding door protects display from wildlife and environmental abuse.

Robust enclosure made of 1.9 and 1.5 mm (14 and 16 gauge) zinc-plated and powder coated steel to stand up to the toughest environmental conditions.

Removable bottom gland plate makes conduit installation simple.



### APPLICATIONS

The SubDrive SolarPAK supports submersible pumping applications:

- Livestock watering
- Tank/Cistern filling
- Wildlife refuge and game farms
- Rural water supply for villages and homesteads
- Irrigation systems
- Fountains
- Vineyards
- Renewable energy projects
- Effluent pumping
- Rain harvesting

### BUILT-IN DIAGNOSTICS & PROTECTION

The SubDrive SolarPAK includes diagnostic features and built-in protection from potential harmful conditions, including:

- Surge
- Underload/Dry run
- Overvoltage
- Locked pump
- Open circuit
- Short circuit
- Overheated controller
- Reverse polarity
- Dead head



## SUBDRIVE SOLARPAK - ORDERING INFORMATION

### SOLARPAK MODEL NUMBERS (NPT)

SolarPAK		SubDrive Solar Controller		Solar Pump - NPT						Motor		Flow Switch NPT**	
SolarPAK Model	Order No.	Drive Model	Part No.	US GPM	Stages	Solar Pump	Part No.	Basic Model	PEI <sub>CL</sub> Number	HP	Part No.	Model	Part No.
5SDSP-0.75HP	90040510	SD Solar 0.55 kW N3	5870300553	5	18	5SL07S4-PE	90020503	-	-	0.75	2349029204GS	C25	226014102
7SDSP-0.75HP	90040710	SD Solar 0.55 kW N3	5870300553	7	13	7SL07S4-PE	90020703	-	-	0.75	2349029204GS	C25	226014102
10SDSP-0.75HP	90041010	SD Solar 0.55 kW N3	5870300553	10	8	10SL07S4-PE	90021003	-	-	0.75	2349029204GS	C25	226014102
15SDSP-0.75HP	90041510	SD Solar 0.55 kW N3	5870300553	15	6	15SL07S4-PE	90021503	-	-	0.75	2349029204GS	C25	226014102
5SDSP-1.5HP	90040520	SD Solar 1.1 kW N3	5870301113	5	38	5SL2S4-PE	90020510	-	-	1.5	2345049203GS	C25	226014102
7SDSP-1.5HP	90040720	SD Solar 1.1 kW N3	5870301113	7	30	7SL2S4-PE	90020710	-	-	1.5	2345049203GS	C25	226014102
10SDSP-1.5HP	90041020	SD Solar 1.1 kW N3	5870301113	10	18	10SL2S4-PE	90021010	-	-	1.5	2345049203GS	C25	226014102
15SDSP-1.5HP	90041520	SD Solar 1.1 kW N3	5870301113	15	14	15SL2S4-PE	90021510	-	-	1.5	2345049203GS	C25	226014102
25SDSP-1.5HP	90042520	SD Solar 1.1 kW N3	5870301113	25	10	25SL2S4-PE	90022510	-	-	1.5	2345049203GS	F21	226019102
35SDSP-1.5HP	90043520*	SD Solar 1.1 kW N3	5870301113	35	9	35FH2S4-PE	93653509	35S4	0.83	1.5	2345049203GS	F21	226019102
45SDSP-1.5HP	90044520*	SD Solar 1.1 kW N3	5870301113	45	7	45FH2S4-PE	93654507	45S4	0.89	1.5	2345049203GS	F21	226019102
90SDSP-1.5HP	90049020*	SD Solar 1.1 kW N3	5870301113	90	6	90FH2S4-PE	93659006	90S4	0.92	1.5	2345049203GS	F21	226019102
7SDSP-3.0HP	90040730	SD Solar 2.2 kW N3	5870301223	7	38	7SL3S4-PE	90020712	-	-	3	2343062604G	C25	226014102
10SDSP-3.0HP	90041030	SD Solar 2.2 kW N3	5870301223	10	24	10SL3S4-PE	90021012	-	-	3	2343062604G	C25	226014102
15SDSP-3.0HP	90041530	SD Solar 2.2 kW N3	5870301223	15	19	15SL3S4-PE	90021512	-	-	3	2343062604G	C25	226014102
25SDSP-3.0HP	90042530	SD Solar 2.2 kW N3	5870301223	25	14	25SL3S4-PE	90022512	-	-	3	2343062604G	F21	226019102
35SDSP-3.0HP	90043530*	SD Solar 2.2 kW N3	5870301223	35	12	35FH3S4-PE	93653512	35S4	0.83	3	2343062604G	F21	226019102
45SDSP-3.0HP	90044530*	SD Solar 2.2 kW N3	5870301223	45	10	45FH3S4-PE	93654510	45S4	0.89	3	2343062604G	F21	226019102
90SDSP-3.0HP	90049030*	SD Solar 2.2 kW N3	5870301223	90	8	90FH3S4-PE	93659008	90S4	0.92	3	2343062604G	F21	226019102

\* High capacity pumps, 35 US gpm (100 lpm) and higher, in a SolarPAK are not supplied with an internal check valve. Output flow may vary due to additional head requirements from external check valve.

\*\* A -30 foot (10 meter) cable for use with the flow switch is included in SolarPAKs requiring one.

### SUBDRIVE SOLARPAK - 0.75 HP (0.55 KW) PERFORMANCE

#### 5SDSP-0.75HP

SubDrive Solar 0.75 hp Controller, 5 US gpm 0.75 hp Pump End, 0.75 hp Motor

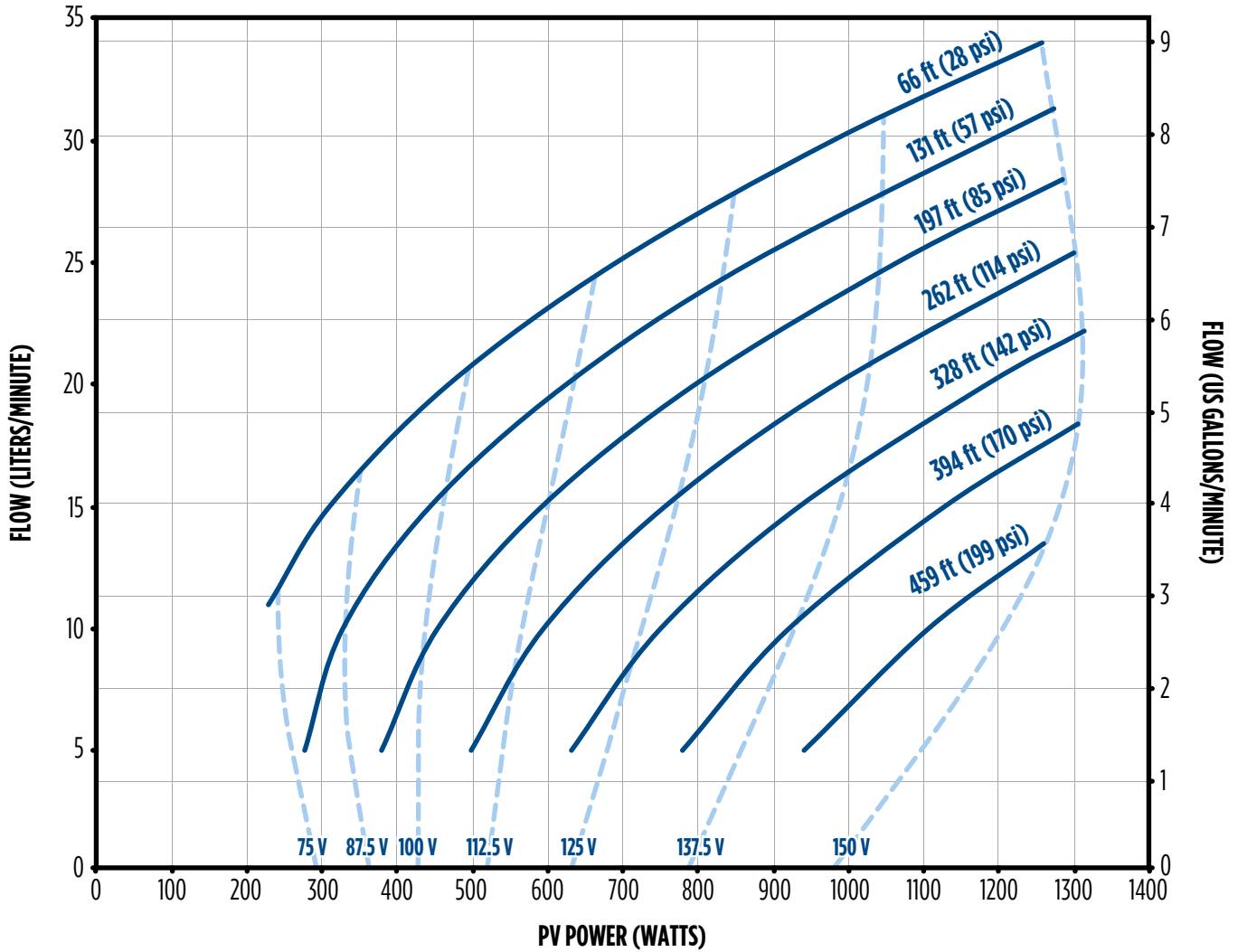

## SUBDRIVE SOLARPAK - 0.75 HP (0.55 KW) PERFORMANCE

### 7SDSP-0.75HP

SubDrive Solar 0.75 hp Controller, 7 US gpm 0.75 hp Pump End, 0.75 hp Motor

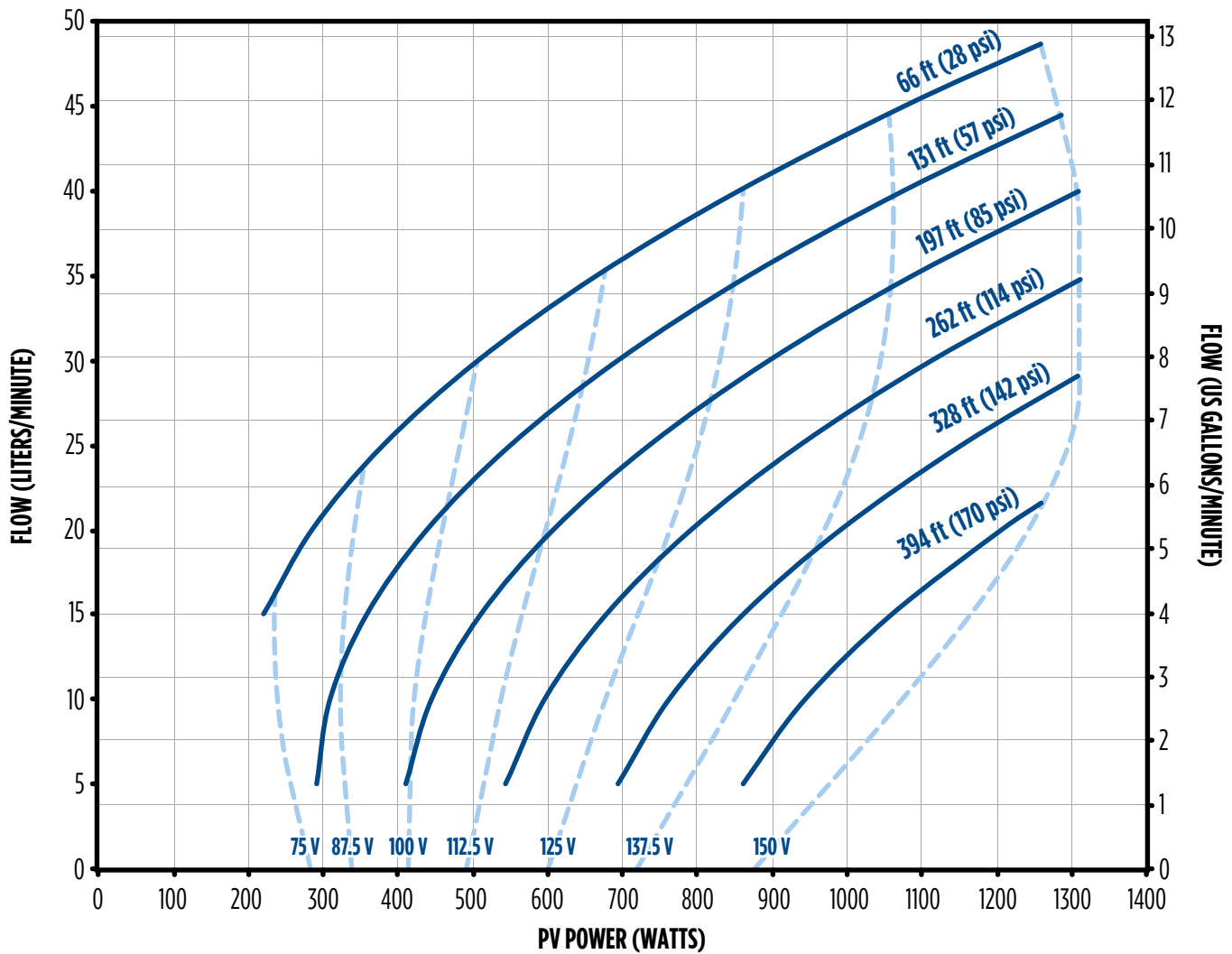



### SUBDRIVE SOLARPAK - 0.75 HP (0.55 KW) PERFORMANCE

#### 10SDSP-0.75HP

SubDrive Solar 0.75 hp Controller, 10 US gpm 0.75 hp Pump End, 0.75 hp Motor

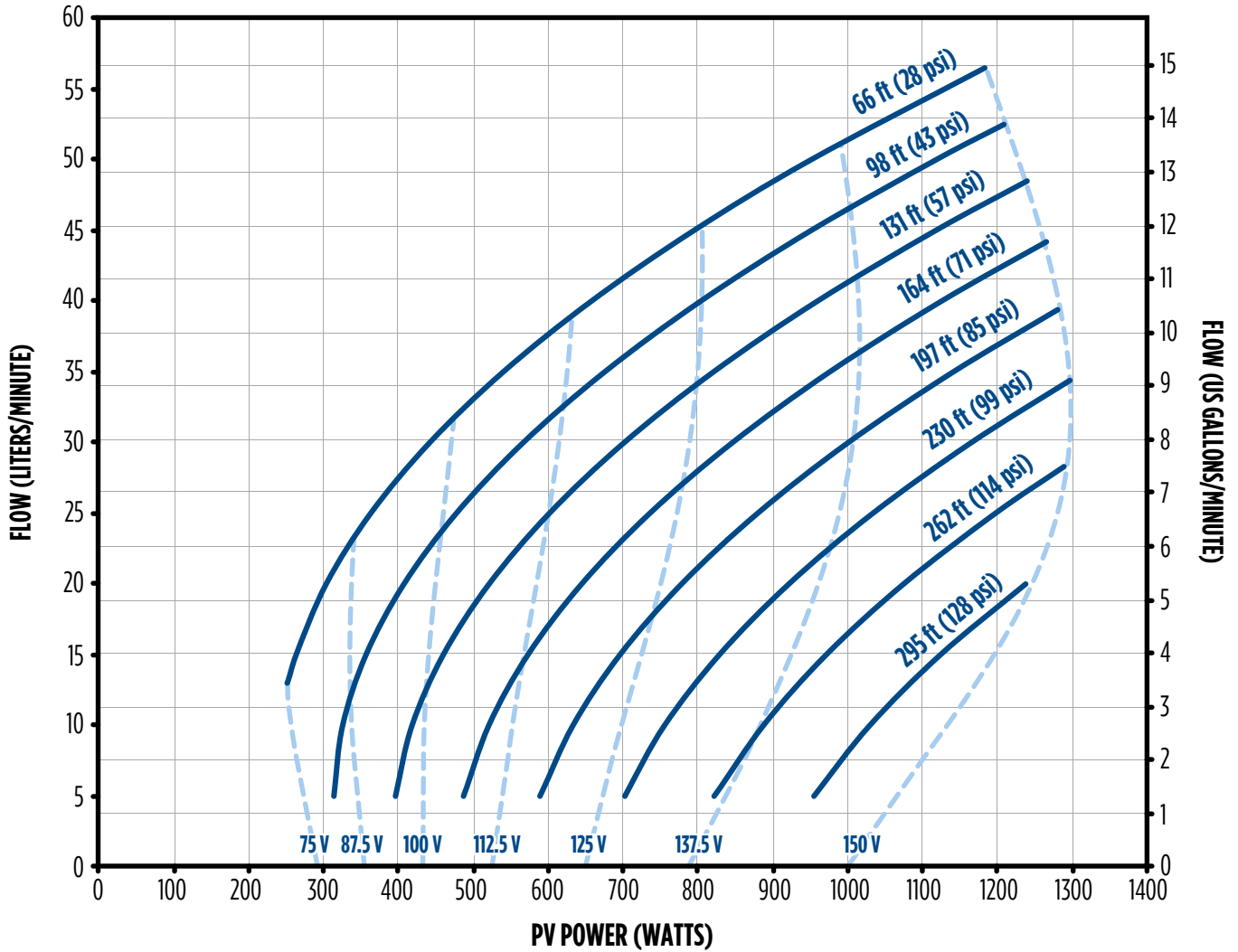

## SUBDRIVE SOLARPAK - 0.75 HP (0.55 KW) PERFORMANCE

### 15SDSP-0.75HP

SubDrive Solar 0.75 hp Controller, 15 US gpm 0.75 hp Pump End, 0.75 hp Motor

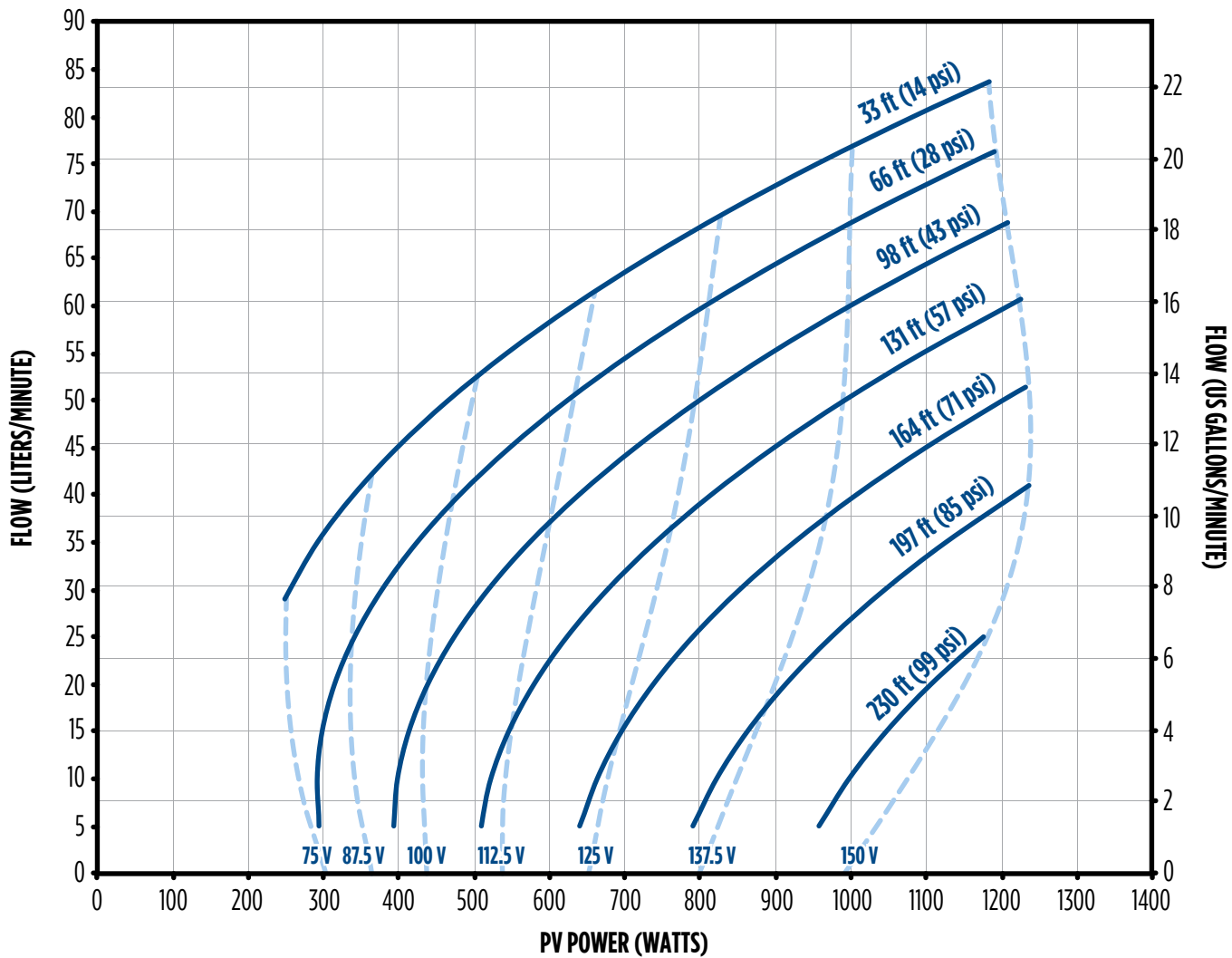

## SUBDRIVE SOLARPAK - 1.5 HP (1.1 KW) PERFORMANCE

### 5SDSP-1.5HP

SubDrive Solar 1.5 hp Controller, 5 US gpm 1.5 hp Pump End, 1.5 hp Motor

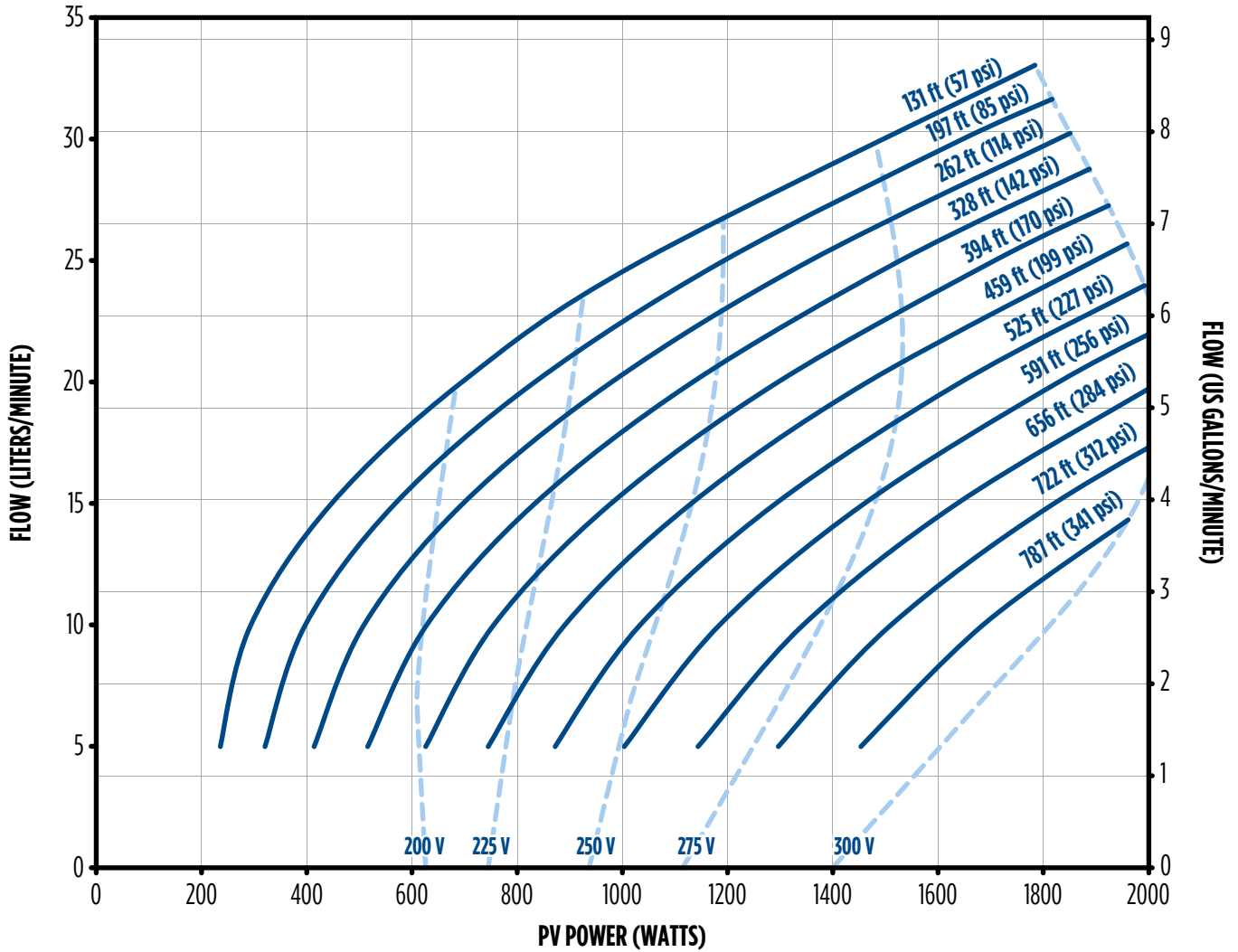

## SUBDRIVE SOLARPAK - 1.5 HP (1.1 KW) PERFORMANCE

### 7SDSP-1.5HP

SubDrive Solar 1.5 hp Controller, 7 US gpm 2.0 hp Pump End, 1.5 hp Motor

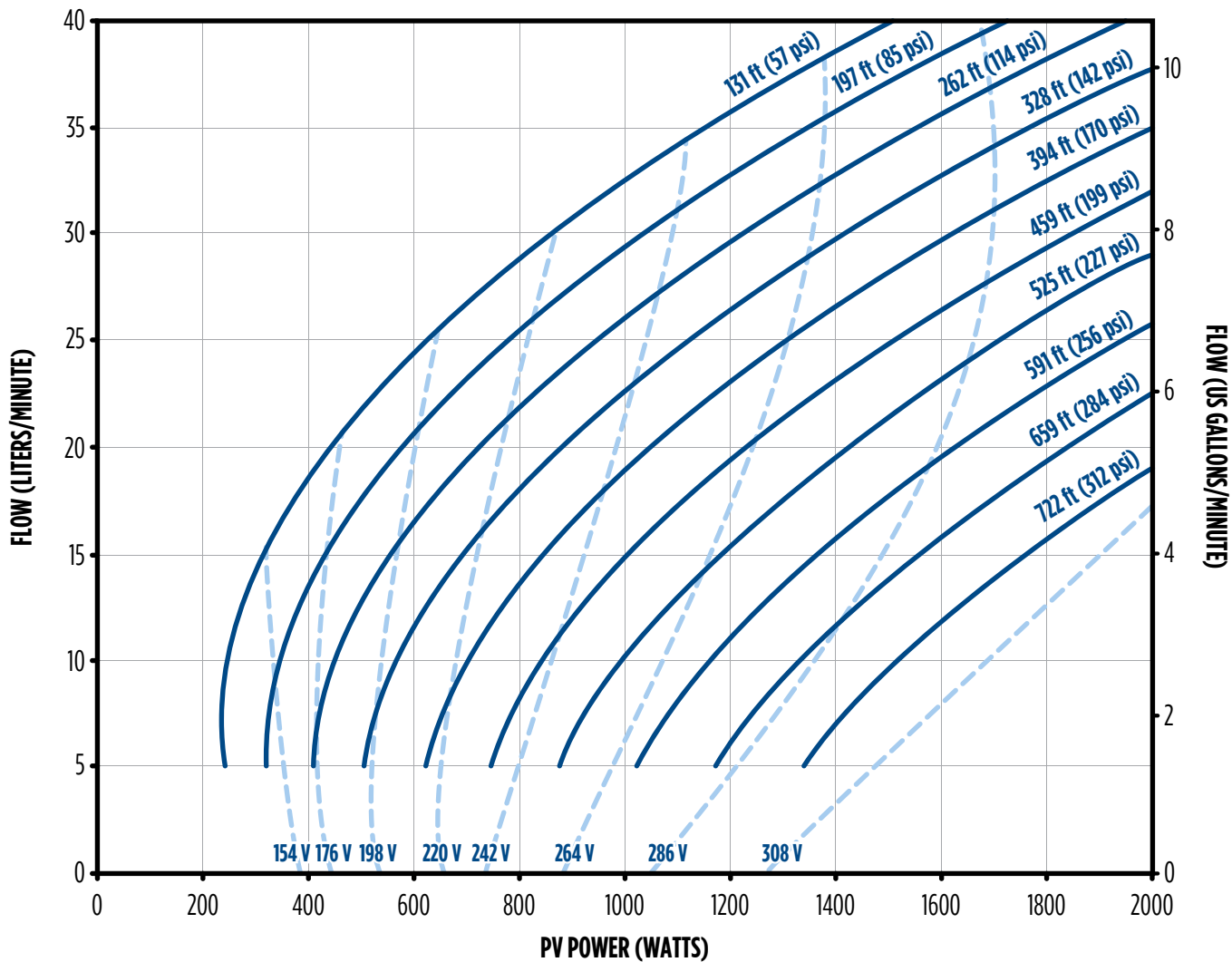

### SUBDRIVE SOLARPAK - 1.5 HP (1.1 KW) PERFORMANCE

#### 10SDSP-1.5HP

SubDrive Solar 1.5 hp Controller, 10 US gpm 2.0 hp Pump End, 1.5 hp Motor

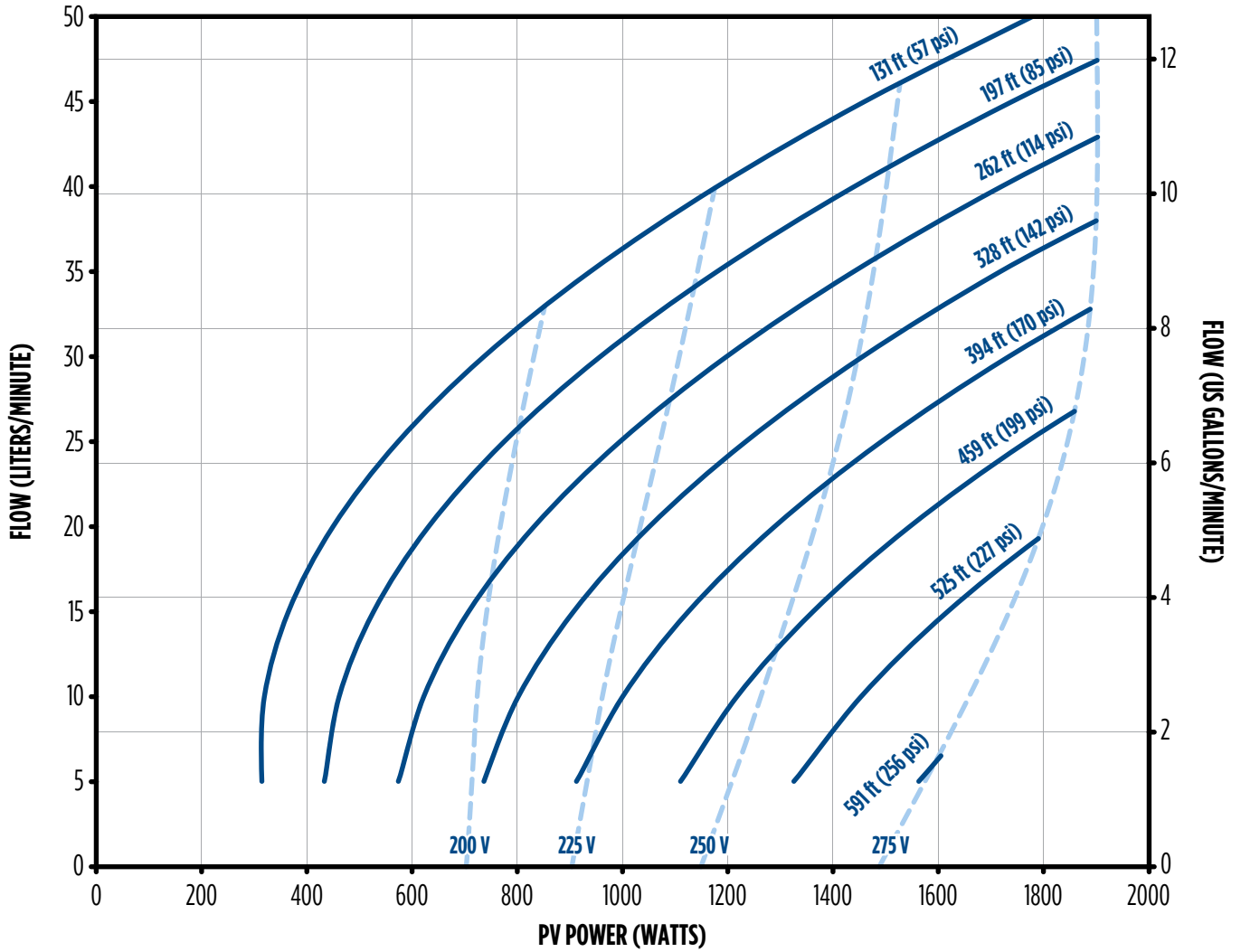

## SUBDRIVE SOLARPAK - 1.5 HP (1.1 KW) PERFORMANCE

### 15SDSP-1.5HP

SubDrive Solar 1.5 hp Controller, 15 US gpm 2.0 hp Pump End, 1.5 hp Motor

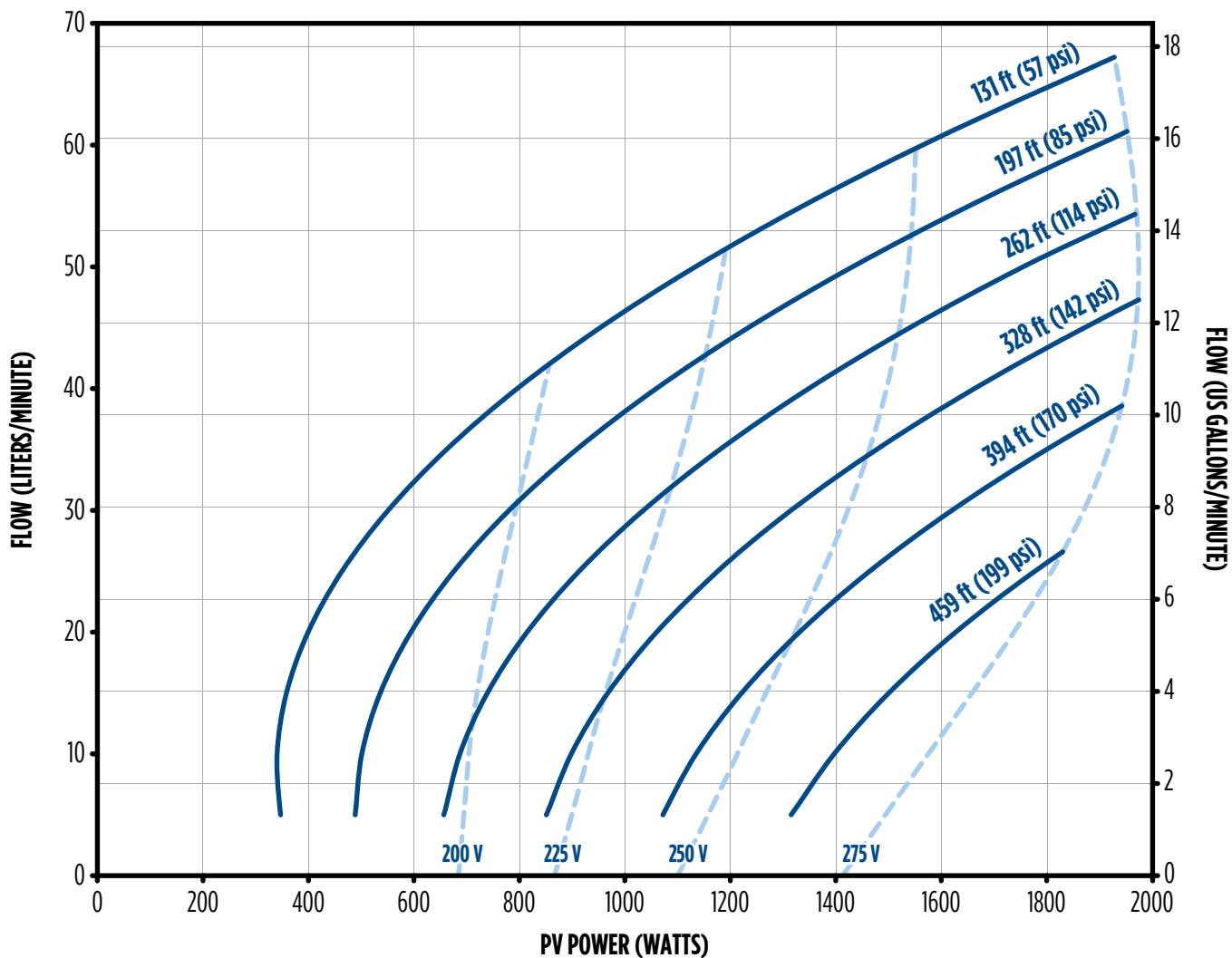

### SUBDRIVE SOLARPAK - 1.5 HP (1.1 KW) PERFORMANCE

#### 25SDSP-1.5HP

SubDrive Solar 1.5 hp Controller, 25 US gpm 2.0 hp Pump End, 1.5 hp Motor

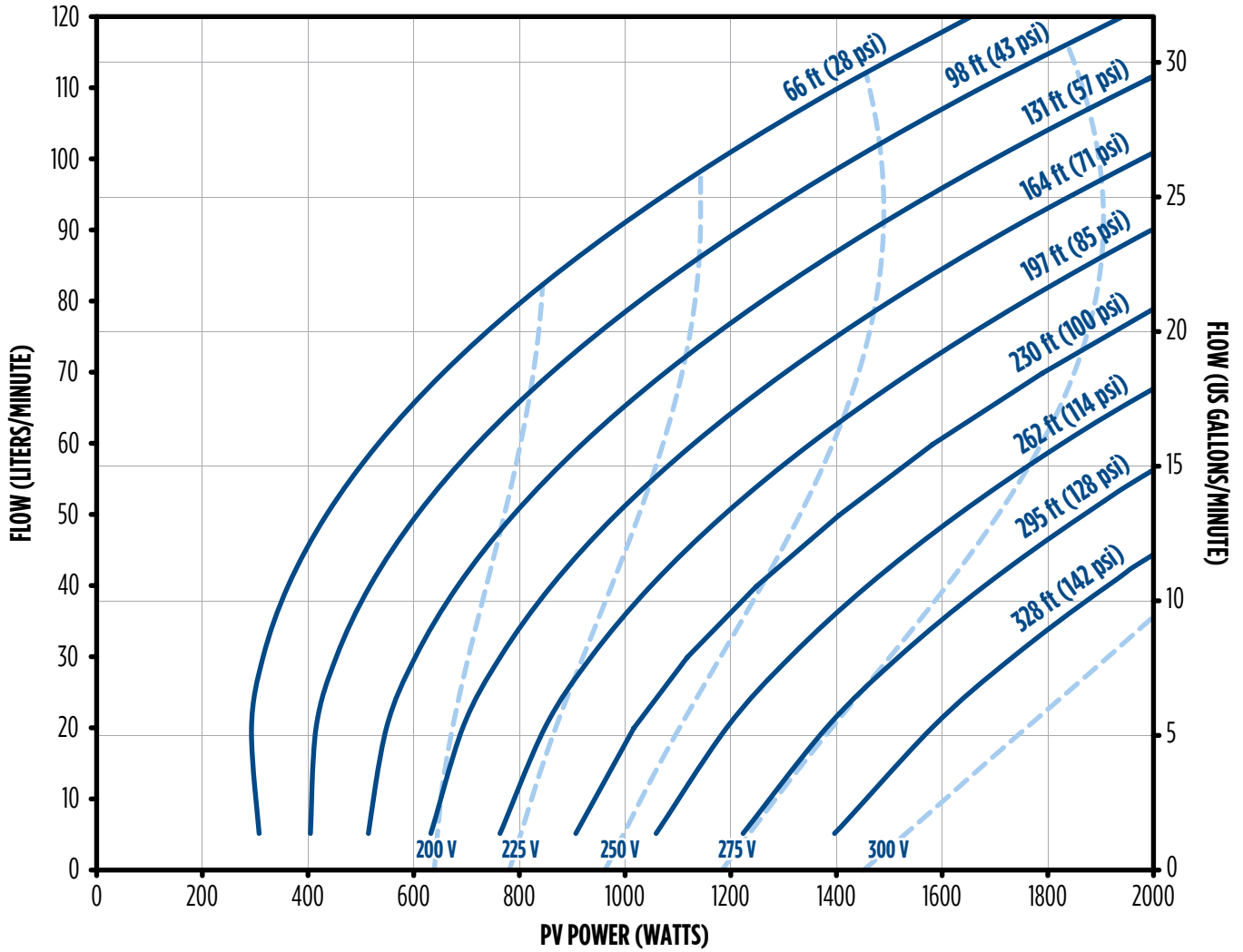

## SUBDRIVE SOLARPAK - 1.5 HP (1.1 KW) PERFORMANCE

35SDSP-1.5HP

SubDrive Solar 1.5 hp Controller, 35 US gpm 2.0 hp Pump End, 1.5 hp Motor

Basic Model	PEL Number
35S4	0.83

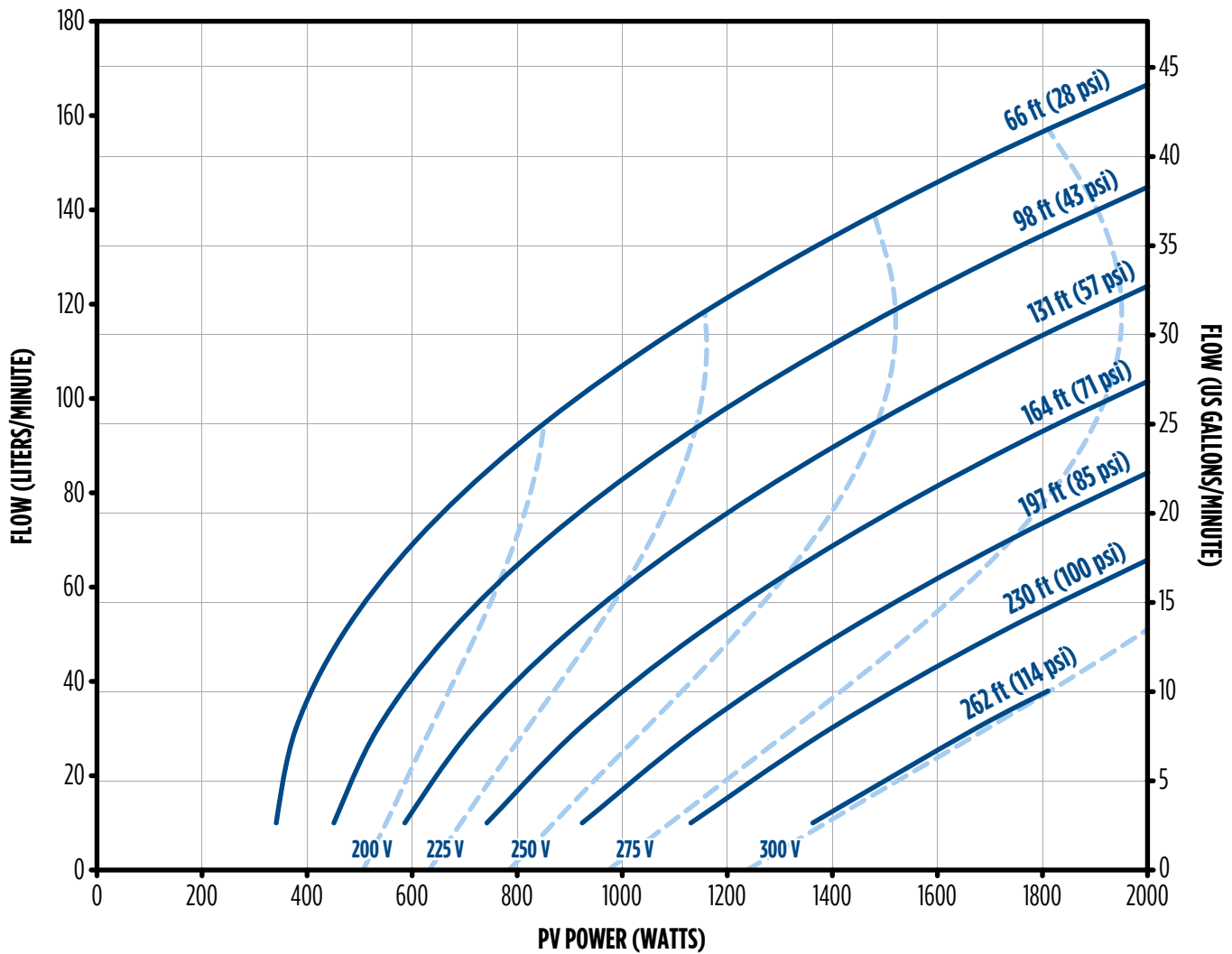



### SUBDRIVE SOLARPAK - 1.5 HP (1.1 KW) PERFORMANCE

45SDSP-1.5HP

SubDrive Solar 1.5 hp Controller, 45 US gpm 2.0 hp Pump End, 1.5 hp Motor

Basic Model	PEI <sub>CL</sub> Number
45S4	0.89

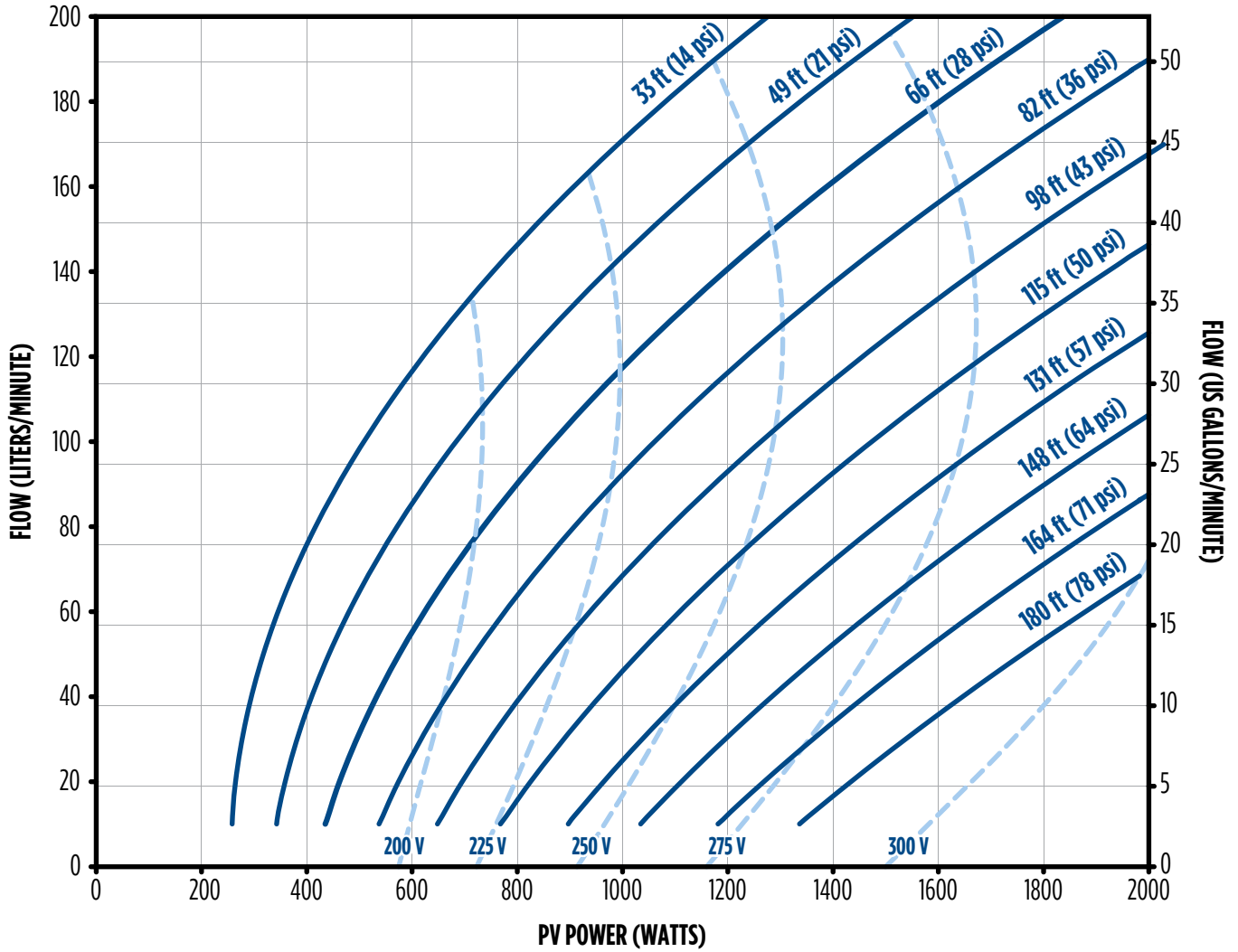

## SUBDRIVE SOLARPAK - 1.5 HP (1.1 KW) PERFORMANCE

90SDSP-1.5HP

SubDrive Solar 1.5 hp Controller, 90 US gpm 2.0 hp Pump End, 1.5 hp Motor

Basic Model	PEL Number
90S4	0.92

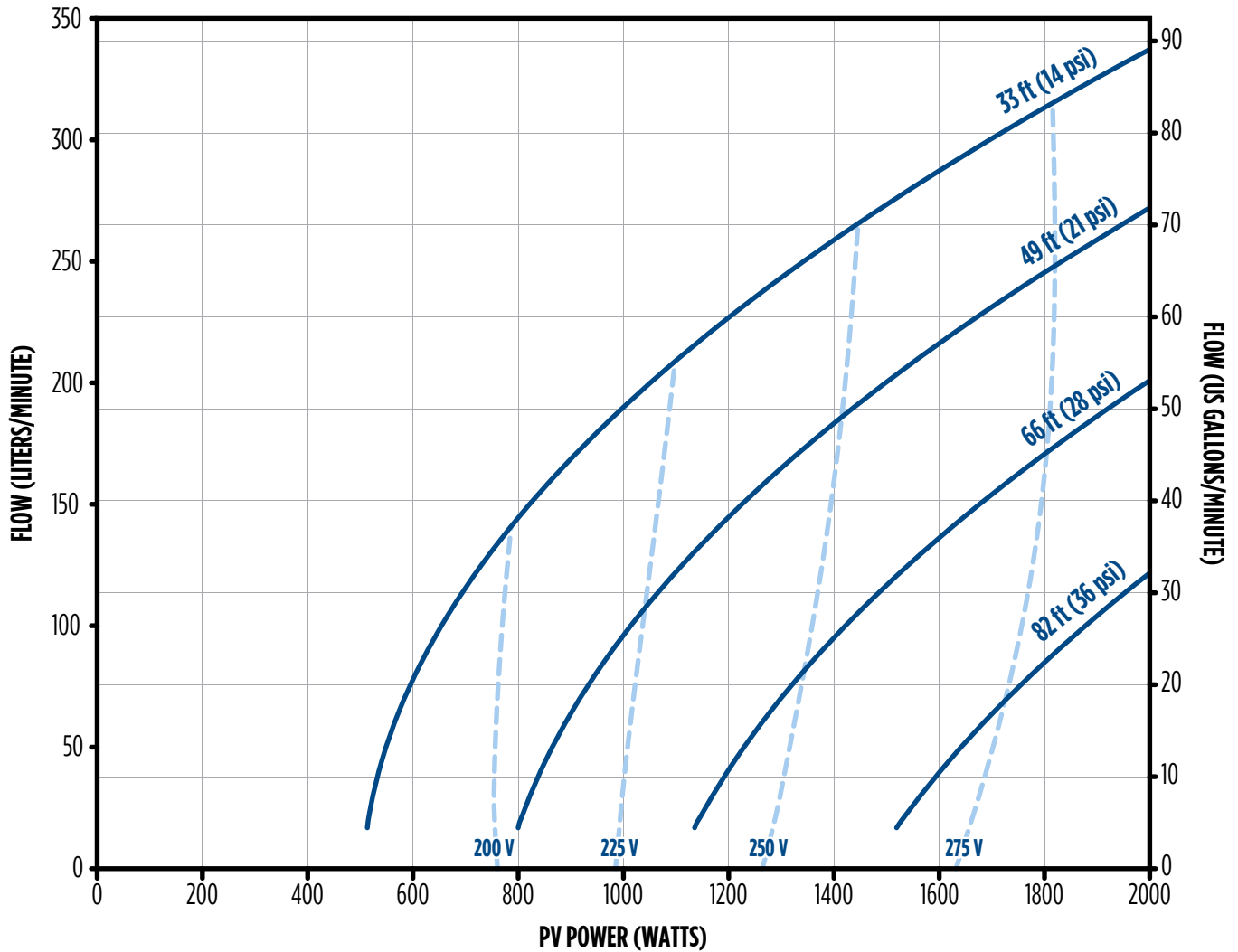

### SUBDRIVE SOLARPAK - 3.0 HP (2.2 KW) PERFORMANCE

#### 7SDSP-3.0HP

SubDrive Solar 3.0 hp Controller, 7 US gpm 2.0 hp Pump End, 3.0 hp Motor

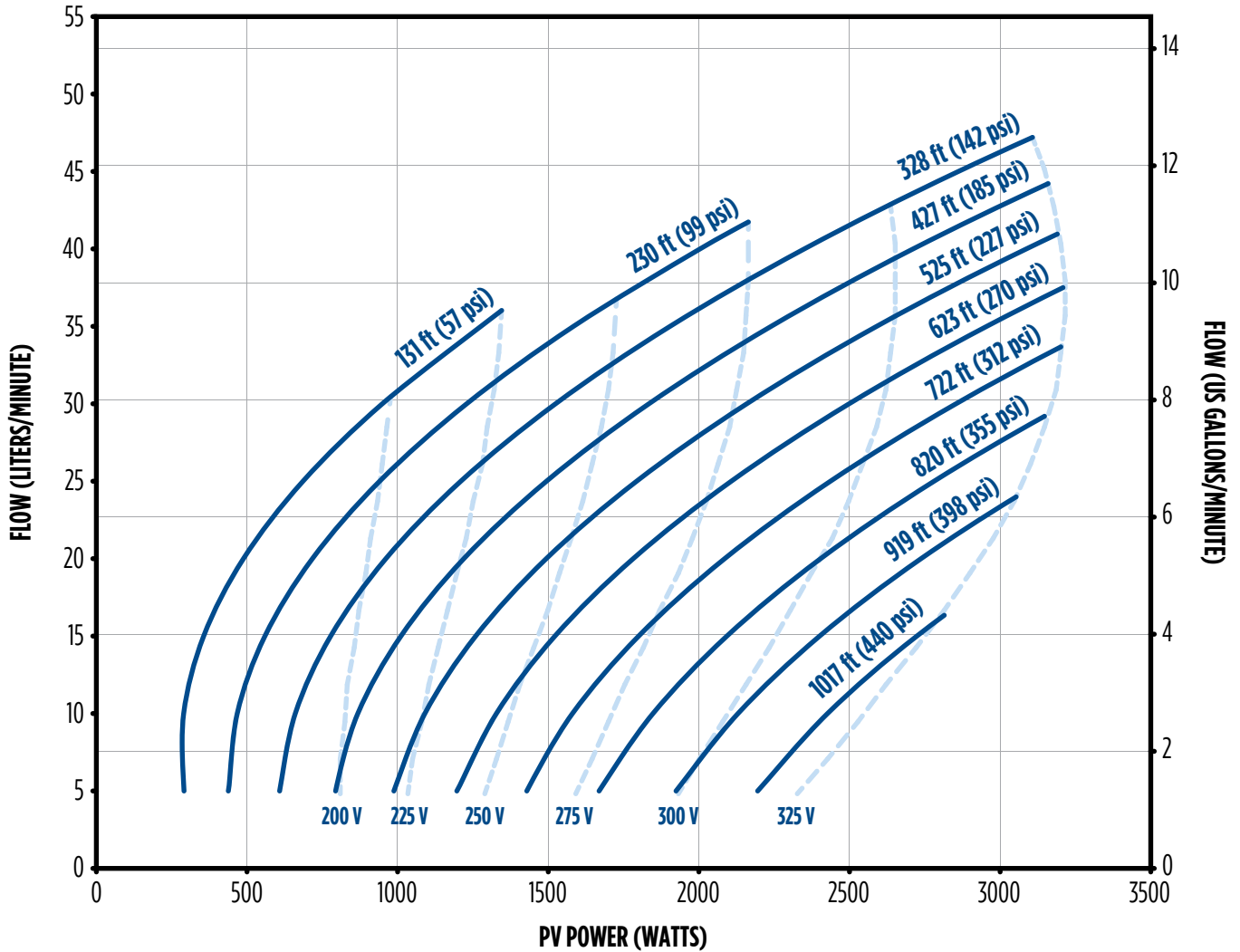

## SUBDRIVE SOLARPAK - 3.0 HP (2.2 KW) PERFORMANCE

### 10SDSP-3.0HP

SubDrive Solar 3.0 hp Controller, 10 US gpm 2.0 hp Pump End, 3.0 hp Motor

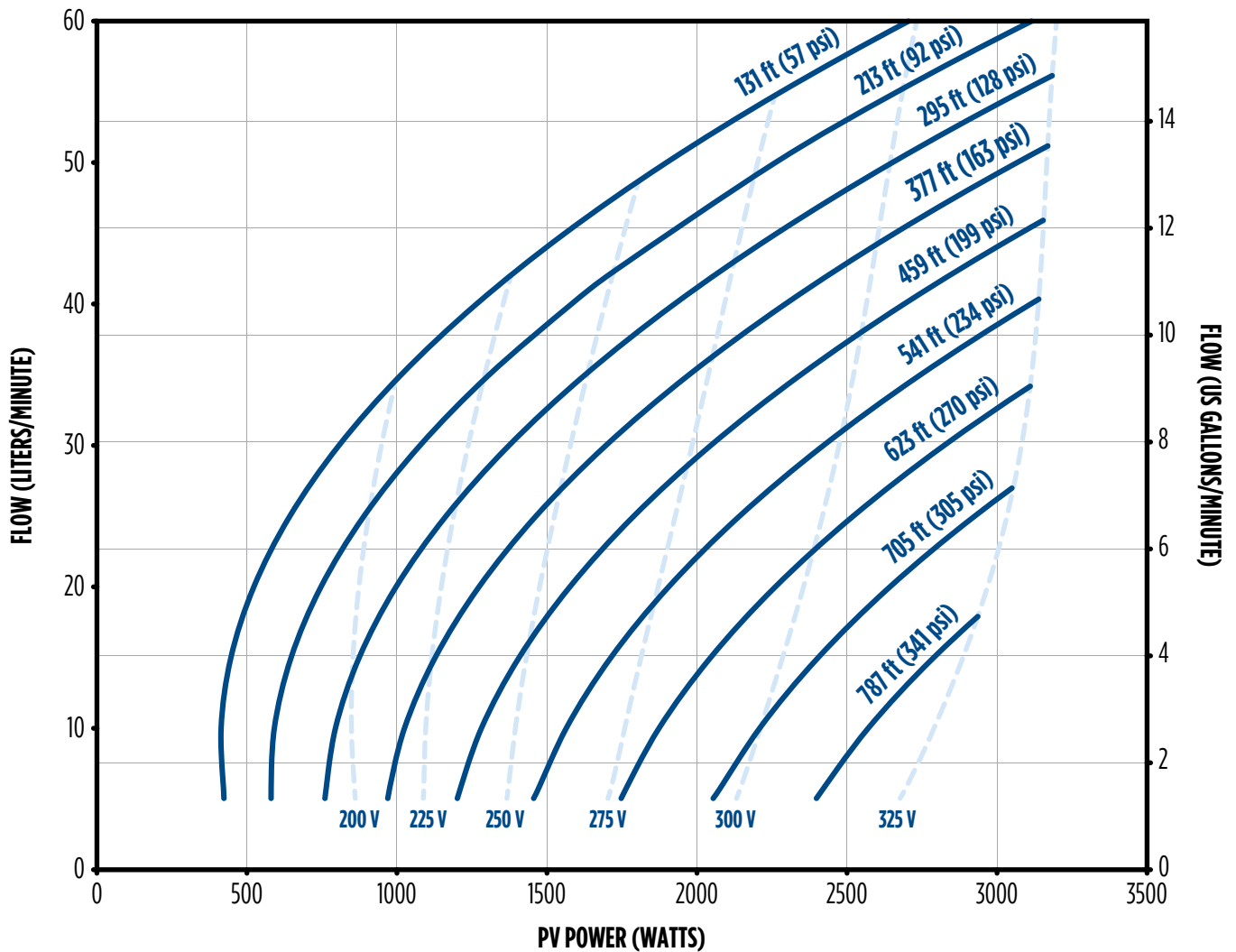

## SUBDRIVE SOLARPAK - 3.0 HP (2.2 KW) PERFORMANCE

### 15SDSP-3.0HP

SubDrive Solar 3.0 hp Controller, 15 US gpm 2.0 hp Pump End, 3.0 hp Motor

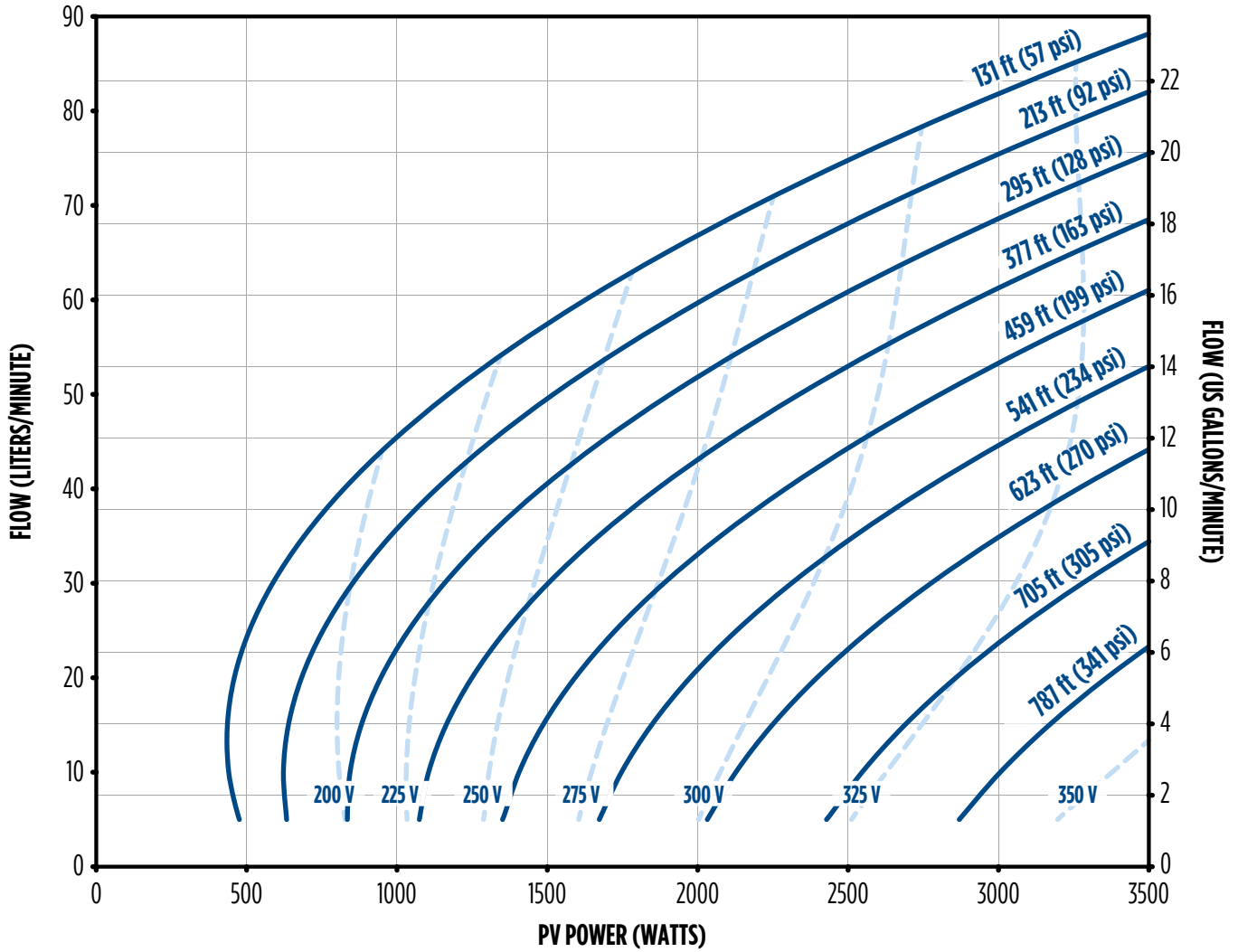

## SUBDRIVE SOLARPAK - 3.0 HP (2.2 KW) PERFORMANCE

### 25SDSP-3.0HP

SubDrive Solar 3.0 hp Controller, 25 US gpm 2.0 hp Pump End, 3.0 hp Motor

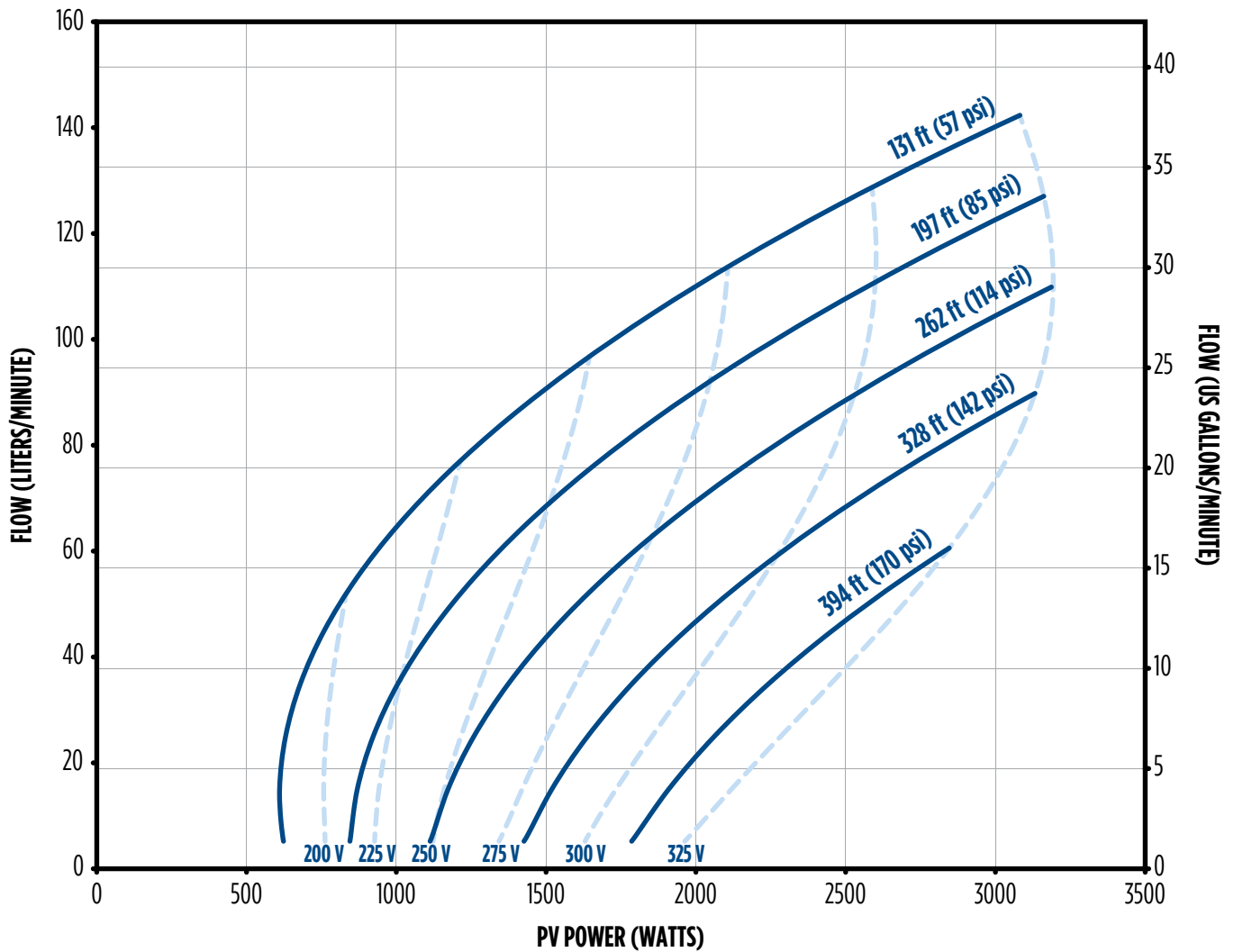

### SUBDRIVE SOLARPAK - 3.0 HP (2.2 KW) PERFORMANCE

35SDSP-3.0HP

SubDrive Solar 3.0 hp Controller, 35 US gpm 2.0 hp Pump End, 3.0 hp Motor

Basic Model	PEI <sub>CL</sub> Number
35S4	0.83

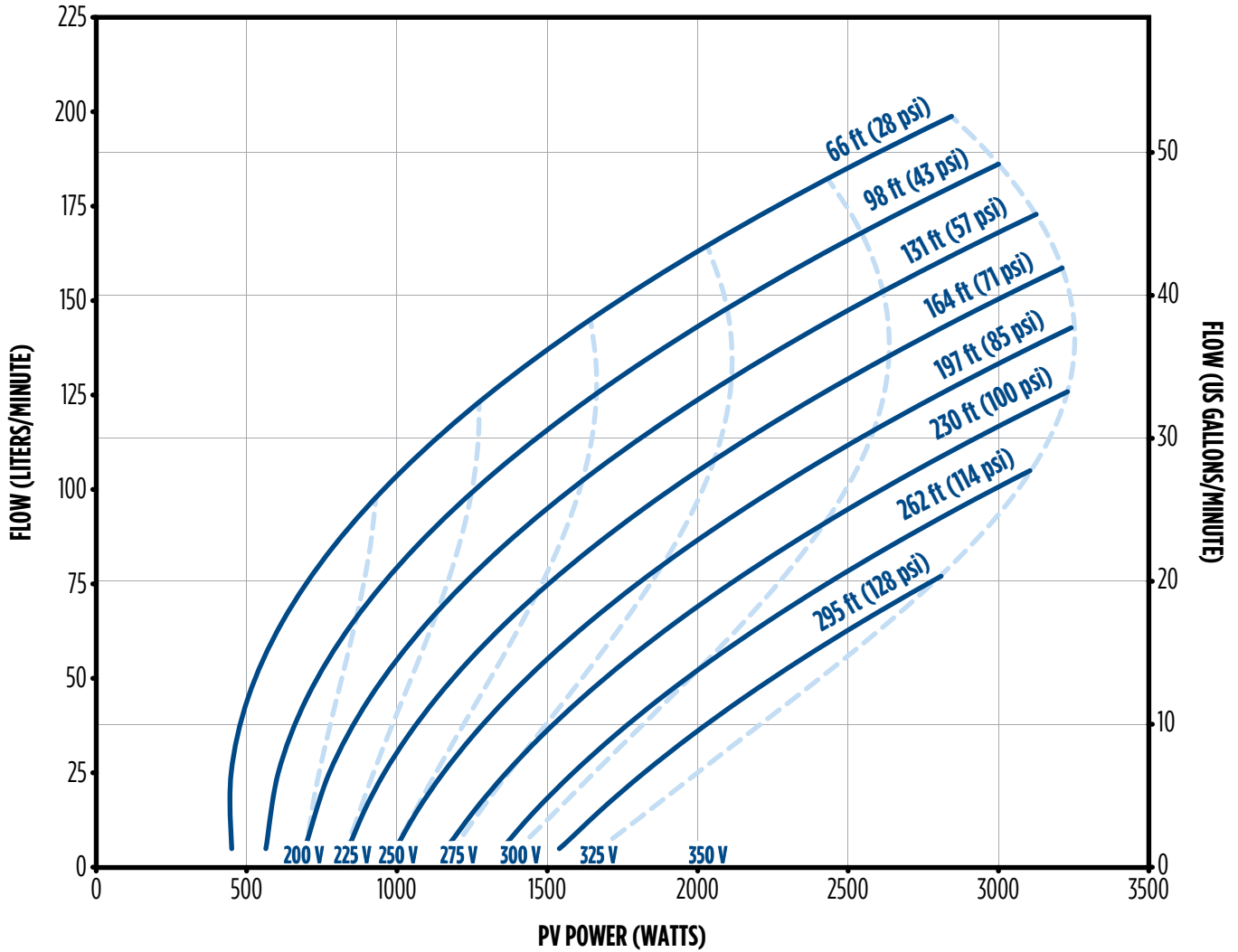

## SUBDRIVE SOLARPAK - 3.0 HP (2.2 KW) PERFORMANCE

45SDSP-3.0HP

SubDrive Solar 3.0 hp Controller, 45 US gpm 2.0 hp Pump End, 3.0 hp Motor

Basic Model	PEI <sub>CL</sub> Number
45S4	0.89

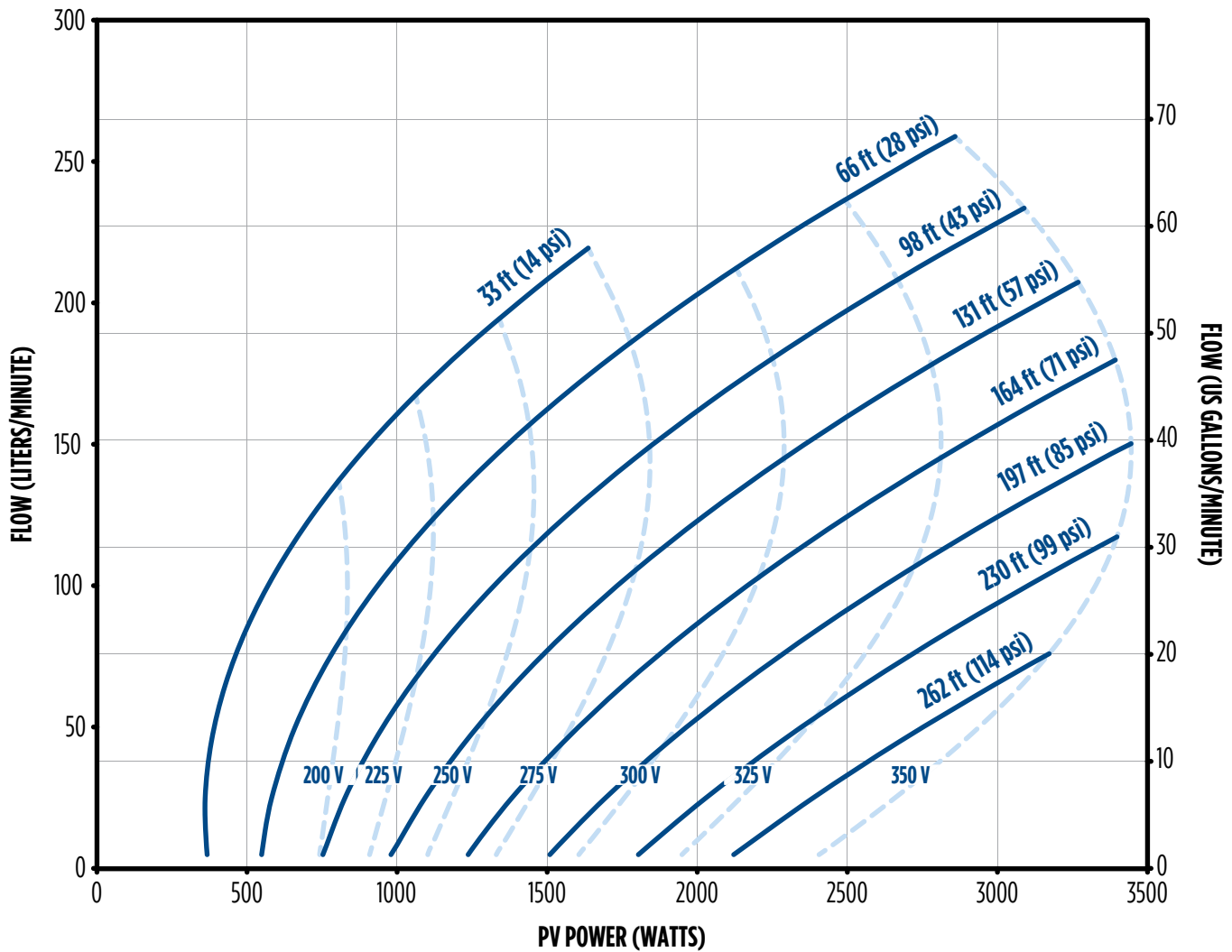



### SUBDRIVE SOLARPAK - 3.0 HP (2.2 KW) PERFORMANCE

#### 90SDSP-3.0HP

SubDrive Solar 3.0 hp Controller, 90 US gpm 2.0 hp Pump End, 3.0 hp Motor

Basic Model	PEI <sub>c</sub> Number
90S4	0.92

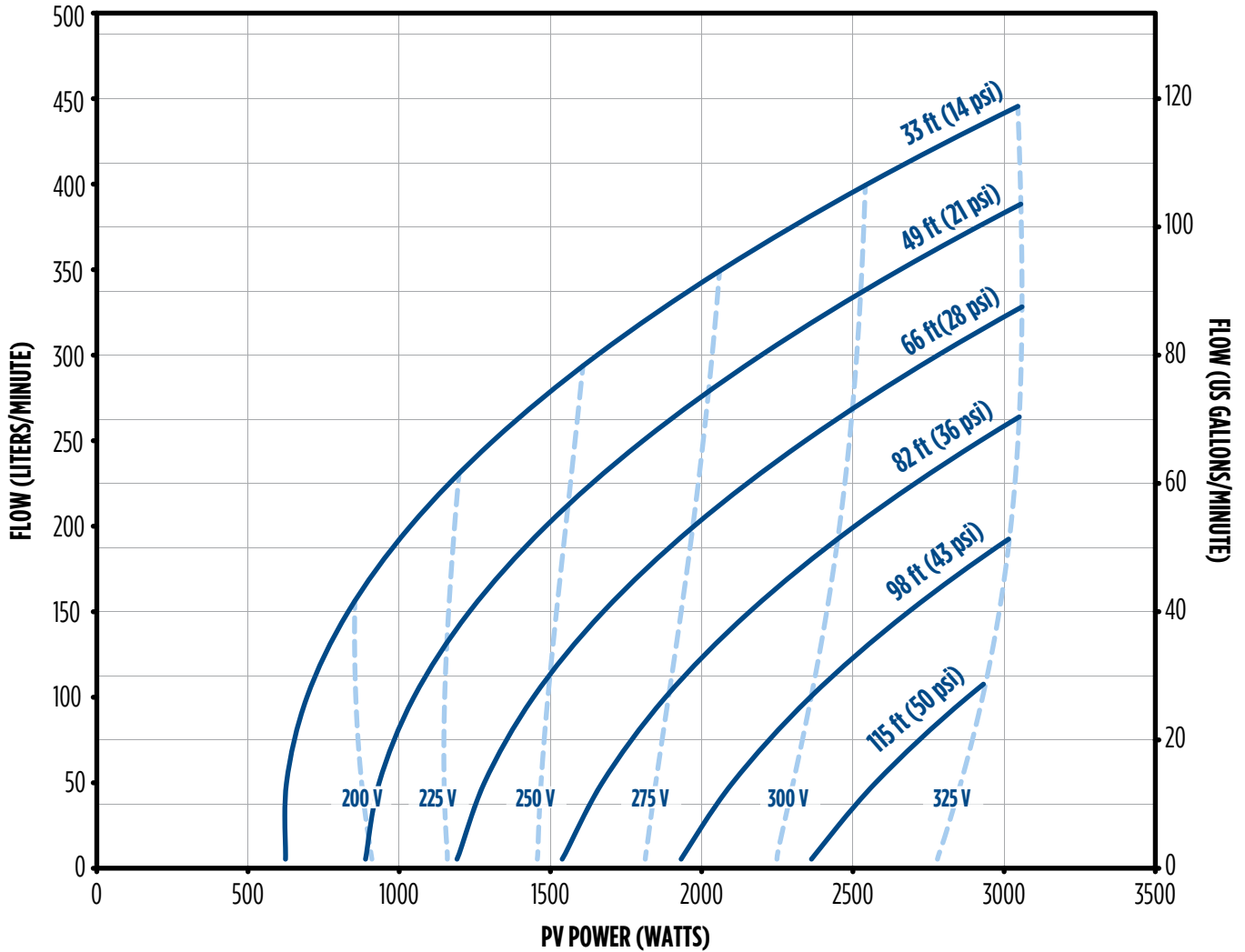

## SUBDRIVE SOLARPAK - DIMENSIONS

### SOLAR PMA DIMENSIONS

System			Pump End				PMA							
HP	US GPM	Stages	HP	Weight		Discharge (in)	Weight		A		B		C	
				lbs	kg		lbs	kg	in	mm	in	mm	in	mm
0.75	5	18	0.75	12	6	1-1/4	33	15	22.6	574	10.64	270	33.2	844
	7	13		11	5		32	15	18.4	467	10.64	270	29.0	737
	10	8		10	5		31	14	14.14	359	10.64	270	24.8	629
	15	6		9	4		30	14	12.39	315	10.64	270	23.0	585
1.5	5	38	2	23	10	1-1/4	52	24	40.9	1039	11.7	298	52.6	1336
	7	30		20	9		49	22	34.1	866	11.73	298	45.8	1164
	10	18		15	7		44	20	25.3	643	11.73	298	37.0	941
	15	14		13	6		42	19	19.57	497	11.73	298	31.3	795
	25	10		11	5	40	18	19.2	488	11.73	298	30.9	786	
	35	9		10	5	39	18	17	431	11.73	298	28.7	728	
	45	7		9	4	38	17	17.6	447	11.73	298	29.3	744	
	90	6		10	5	39	18	23.4	594	11.73	298	35.1	892	
3	7	38	3	23	10	1-1/4	64	29	40.9	1039	16.0	407	56.9	1445
	10	24		18	8		59	27	30.7	780	16.0	407	46.7	1186
	15	19		16	7		59	27	26.17	664	16.0	407	42.2	1071
	25	14		13	6		54	24.54	24.11	612	16.0	407	40.1	1019
	35	12		11	5	51	23	20.9	530	16.0	407	36.9	937	
	45	10		10	5	50	23	22.8	579	16.0	407	38.8	985.52	
	90	8		12	6	52	24	31.4	798	16.0	407	47.4	1204	

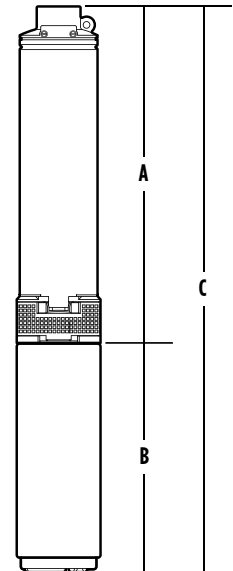

NOTE: Diameter with cable guard 3.75" (95.3 mm) for 5 & 7 gpm pumps; all others 3.90" (99.1 mm).  
High capacity pumps, 35 US gpm (100 lpm) and higher, in a SolarPAK are not supplied with an internal check valve.

### SOLAR CONTROLLER DIMENSIONS

Dimensions	A	B	C	D	E	F	G.1	G.2
Inches	10.2	18.3	21.0	20.0	6.0	3.0	8.7	10.4
Centimeters	25.9	46.4	53.4	50.8	15.2	7.6	22.1	26.5

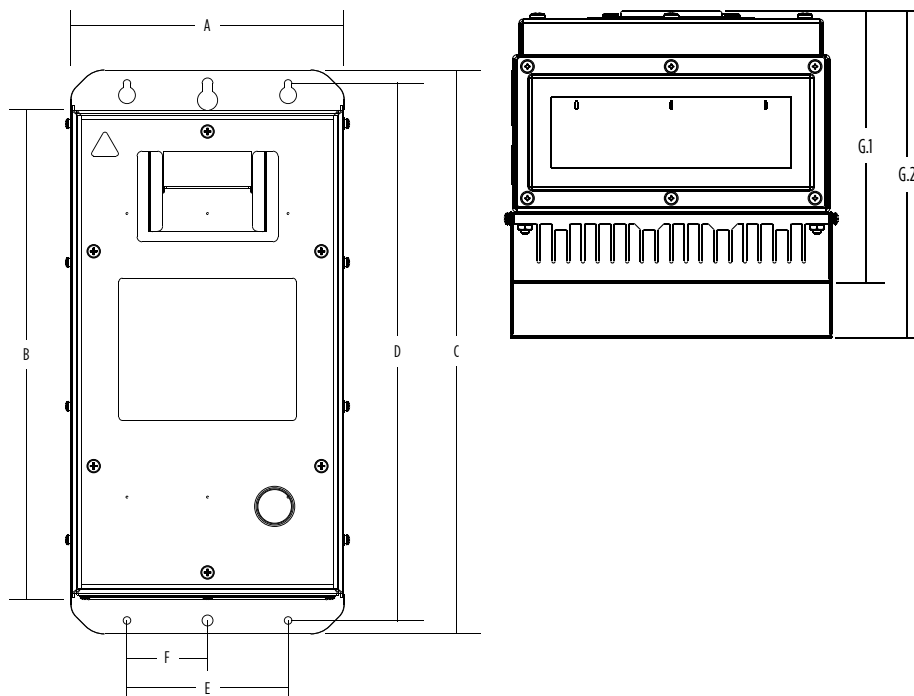

## SUBDRIVE SOLARPAK - DRIVE SPECIFICATIONS

### SOLAR CONTROLLER

	0.75 hp (0.55 kW) Model	1.5 hp (1.1 kW) Model	3.0 hp (2.2 kW) Model
Controller Model No.	5870300553	5870301113	5870301223
<b>Output</b>			
Output Voltage, Max	100 V AC, 3-phase	200 V AC, 3-phase	200 V AC, 3-phase
Max Amps (RMS)	8.6 A, each phase	6.8 A, each phase	12.5 A, each phase
Output Frequency	30-60 Hz	30-58 Hz	30-68 Hz
Efficiency at Max Power	96%	96%	96%
<b>PV Source</b>			
Input Voltage, at mpp	*95 - 330 V DC	**190 - 330 V DC	190* - 330 V DC
Max Amps Input	8.7 A DC, continuous	7 A DC, continuous	12 A DC, continuous
Power at mpp	Up to 1400 Watts	Up to 2000 Watts	Up to 3500 Watts
<b>Alternate AC Generator</b>			
Input Voltage, max	230 V AC, single-phase	230 V AC, single-phase	230 V AC, single-phase
Max Amps (RMS)	9.6 A	16 A	25 A
Power and VA capability	Follow Instruction Manual for proper Generator Sizing Data		
<b>For Use With</b>			
Franklin Electric Motor	234902----	234504----	234306----
<b>Controller Size (L x W x D)</b>			
in (cm)	21.00 x 10.19 x 8.61 (53.34 x 25.87 x 21.87)	21.00 x 10.19 x 8.61 (53.34 x 25.87 x 21.87)	21.00 x 10.19 x 10.36 (53.34 x 25.87 x 26.31)
<b>Controller Weight</b>			
lbs (kg)	41 (19)	41 (19)	47 (22)
<b>Operating Conditions</b>			
Temperature Range	122 °F (104 °F max when using AC generator); -25 °C to 50 °C (40 °C max when using AC generator)		
Relative Humidity Range	0 to 100% Condensing		

\* Drive will attempt to start the pump/motor at 95 V DC, and attempt to continue operation down to 75 V DC.

\*\* Drive will attempt to start the pump/motor at 190 V DC, and attempt to continue operation down to 150 V DC. Absolute maximum open circuit voltage input to the controller = 410 VOC for all controller models.

\*\*\* Motors shown above include an individual conductor lead installed in the motor. For replacement motors without a lead, use part numbers: 1.5 hp / 1.1 kW (2345041903S) and 3.0 hp / 2.2 kW (2343062504)

## FHOTON™ SOLARPAK (1/2–1.5 HP, 0.37–1.1 KW)

The Photon™ SolarPAK is the system solution to your solar pumping requirements. By utilizing quality components, innovative thinking based on global market inputs, and a technical expertise in groundwater pumping, Franklin Electric has developed a rugged system which tackles the challenges of harsh and remote environments. No other system delivers the features, benefits, and reliability in just one package!

### FEATURES

- High-flow system for faster tank-fill and significant water output
- Proven motor and pump technology for long-term reliability
- Robust IP66, NEMA 4 enclosure minimizes impact from wildlife, insects, dust, and weather
- Operating status and fault conditions indicated by multi-color LED
- Terminals provided for an optional data communications board
- Maximum Power Point Tracking (MPPT) for maximizing efficiency of input power
- Soft-start feature prevents water hammer and increases system life
- Simple installation with no required maintenance
- Built-in diagnostics and protection
- cULus and UL approved

### SOLARPAK CONTENTS

- Franklin Electric 4" submersible motor
  - Motor and drive ratings available: 0.5, 0.75 or 1.5 hp (0.38, 0.55 or 1.1 kW)
- Franklin Electric 4" submersible pump
  - Variety of flow rates available: 5, 7, 10, 15, 25, 35, 45 or 90 US gpm (18, 25, 30, 45, 70, 100, 150 or 270 lpm)
- Photon™ solar controller
- Flow switch with 30 ft (10 m) cable (optional on 1/2 hp 48V systems)

### SOLARPAK NOMENCLATURE

**XXX FD SP - X.XHP**

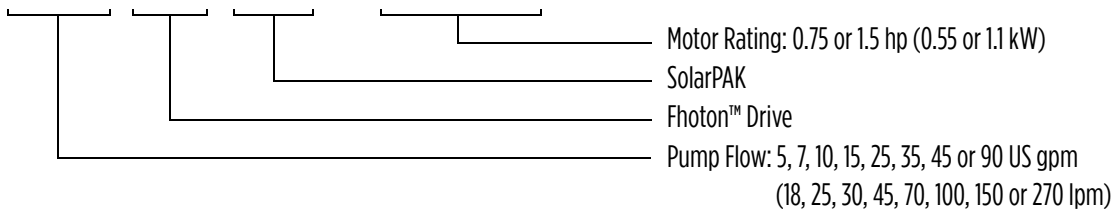

## FHOTON™ SOLARPAK

By utilizing a minimum number of solar panels to generate substantial water pressure, the Photon™ HR SolarPAK delivers a solution for applications with flexible volume requirements.

### FEATURES

- Four-inch NEMA standard construction dimensions
- Flex-shaft that allows for minimal radial wear to the motor
- Proprietary software provides increased dry-run and low-flow protection without the need for external devices
- Legendary four-inch Franklin Electric motor
- Built-in wafer style check valve
- Pump upthrust washer serves as additional shaft protection from excessive wear in the event of reversed rotation
- Serviceability by pump and motor detaching when needed
- Greater flexibility in performance with wider range of input voltages (up to 300 V DC)
- Unique Photon™ drive algorithm provides increased starting torque levels to maximize the available sun power
- cULus and UL approved silicon grease provided for added motor spline protection

### HR SOLARPAK CONTENTS

- Photon™ solar controller: 0.75 hp (0.55 kW)
- Franklin Electric 4" submersible motor: 0.75 hp (0.55 kW)
- Franklin Electric 4" submersible helical rotor pump: 3 or 7 US gpm (10 or 25 lpm)

### HR SOLARPAK NOMENCLATURE

**XXX FD SP - X.XHP - HR**

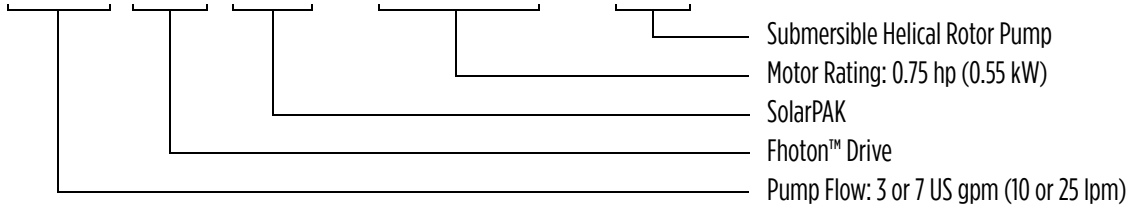

## PHOTON™ SOLARPAK

### COMPONENTS

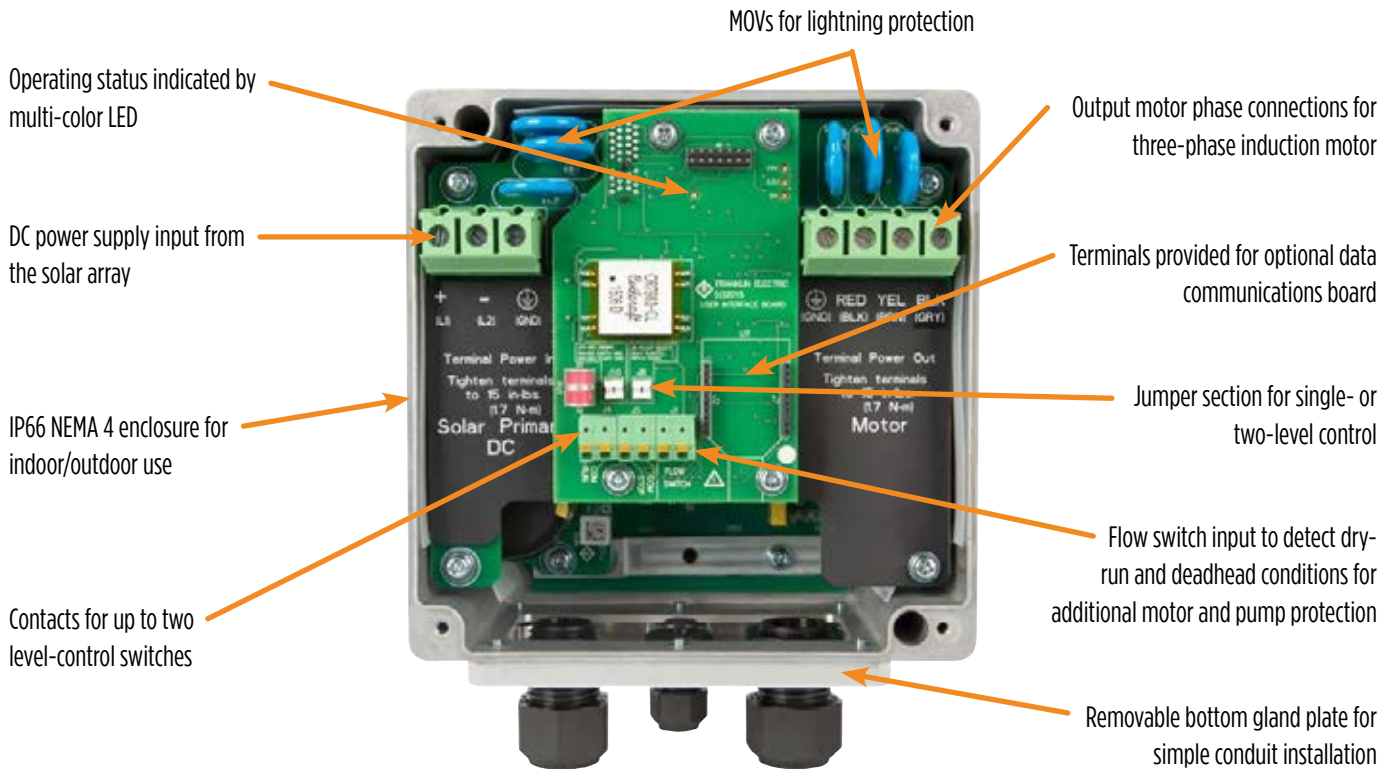

### APPLICATIONS

The Photon™ drive supports submersible pumping applications:

- Livestock watering
- Tank/Cistern filling
- Wildlife refuge and game farms
- Rural water supply for villages and homesteads
- Irrigation systems
- Fountains
- Vineyards
- Renewable energy projects
- Effluent pumping
- Rain harvesting

### BUILT-IN DIAGNOSTICS & PROTECTION

The Photon™ SolarPAK includes diagnostic features and built-in protection from potential harmful conditions, including:

- Surge
- Underload/Dry run
- Overvoltage
- Locked pump
- Open circuit
- Short circuit
- Overheated controller
- Reverse polarity
- Deadhead



## PHOTON™ SOLARPAK - ORDERING INFORMATION

### SOLARPAK MODEL NUMBERS (NPT)

SolarPAK		Photon Solar Controller		Solar Pump (NPT)						Motor		Flow Switch (NPT)**	
Model	Order No.	Model	Part No.	US GPM	Stages	Solar Pump	Part No.	Basic Model	PEI <sub>CL</sub> Number	HP	Part No.	Model	Part No.
3FDSP-0.75HP-HR	90140314	FD Solar 0.55 kW N4	581013000864-SPIP000	3	-	03SL07S4-HR	830012504	-	-	0.75	2349029204GS	-	-
7FDSP-0.75HP-HR	90140714	FD Solar 0.55 kW N4	581013000864-SPIP001	7	-	07SL07S4-HR	830012502	-	-	0.75	2349029204GS	-	-
5FDSP-0.5HP	90040504	FD Solar 0.37 kW N4	58101100984-SP050HP	5	13	5FR05S4-PE	96320500	-	-	0.5	2349049204GS	-	-
7FDSP-0.5HP	90040704	FD Solar 0.37 kW N4	58101100984-SP050HP	7	10	7FR05S4-PE	96320700	-	-	0.5	2349049204GS	-	-
15FDSP-0.5HP	90041504	FD Solar 0.37 kW N4	58101100984-SP050HP	15	4	15FA05S4-PE	93821505	-	-	0.5	2349049204GS	-	-
20FDSP-0.5HP	90042004	FD Solar 0.37 kW N4	58101100984-SP050HP	20	5	20FA05S4-PE	93822005	-	-	0.5	2349049204GS	-	-
5FDSP-0.75HP	90040514	FD Solar 0.55 kW N4	581013000864-SP075HP	5	18	5SL07S4-PE	90020503	-	-	0.75	2349029204GS	C25	226014102
7FDSP-0.75HP	90040714	FD Solar 0.55 kW N4	581013000864-SP075HP	7	13	7SL07S4-PE	90020703	-	-	0.75	2349029204GS	C25	226014102
10FDSP-0.75HP	90041014	FD Solar 0.55 kW N4	581013000864-SP075HP	10	8	10SL07S4-PE	90021003	-	-	0.75	2349029204GS	C25	226014102
15FDSP-0.75HP	90041514	FD Solar 0.55 kW N4	581013000864-SP075HP	15	6	15SL07S4-PE	90021503	-	-	0.75	2349029204GS	C25	226014102
5FDSP-1.5HP	90040524	FD Solar 1.1 kW N4	581014200864-SPI50HP	5	38	5SL2S4-PE	90020510	-	-	1.5	2345049203GS	C25	226014102
7FDSP-1.5HP	90040724	FD Solar 1.1 kW N4	581014200864-SPI50HP	7	30	7SL2S4-PE	90020710	-	-	1.5	2345049203GS	C25	226014102
10FDSP-1.5HP	90041024	FD Solar 1.1 kW N4	581014200864-SPI50HP	10	18	10SL2S4-PE	90021010	-	-	1.5	2345049203GS	C25	226014102
15FDSP-1.5HP	90041524	FD Solar 1.1 kW N4	581014200864-SPI50HP	15	14	15SL2S4-PE	90021510	-	-	1.5	2345049203GS	C25	226014102
25FDSP-1.5HP	90042524	FD Solar 1.1 kW N4	581014200864-SPI50HP	25	10	25SL2S4-PE	90022510	-	-	1.5	2345049203GS	F21	226019102
35FDSP-1.5HP	90043524*	FD Solar 1.1 kW N4	581014200864-SPI50HP	35	9	35FH2S4-PE	93653509	35S4	0.83	1.5	2345049203GS	F21	226019102
45FDSP-1.5HP	90044524*	FD Solar 1.1 kW N4	581014200864-SPI50HP	45	7	45FH2S4-PE	93654507	45S4	0.89	1.5	2345049203GS	F21	226019102
90FDSP-1.5HP	90049024*	FD Solar 1.1 kW N4	581014200864-SPI50HP	90	6	90FH2S4-PE	93659006	90S4	0.92	1.5	2345049203GS	F21	226019102

\*High capacity pumps, 35 US gpm (100 lpm) and higher, in a SolarPAK are not supplied with an internal check valve. Output flow may vary due to additional head requirements from external check valve.

\*\* A -30 foot (10 meter) cable for use with the flow switch is included in SolarPAKs requiring one.

## PHOTON™ SOLARPAK - 0.5 HP (0.37 KW) PERFORMANCE

### 5FDSP-0.5HP

Photon™ Solar 0.5 hp Controller, 3200 Series 5 gpm (18 lpm) 0.5 hp Pump End, 0.5 hp Motor

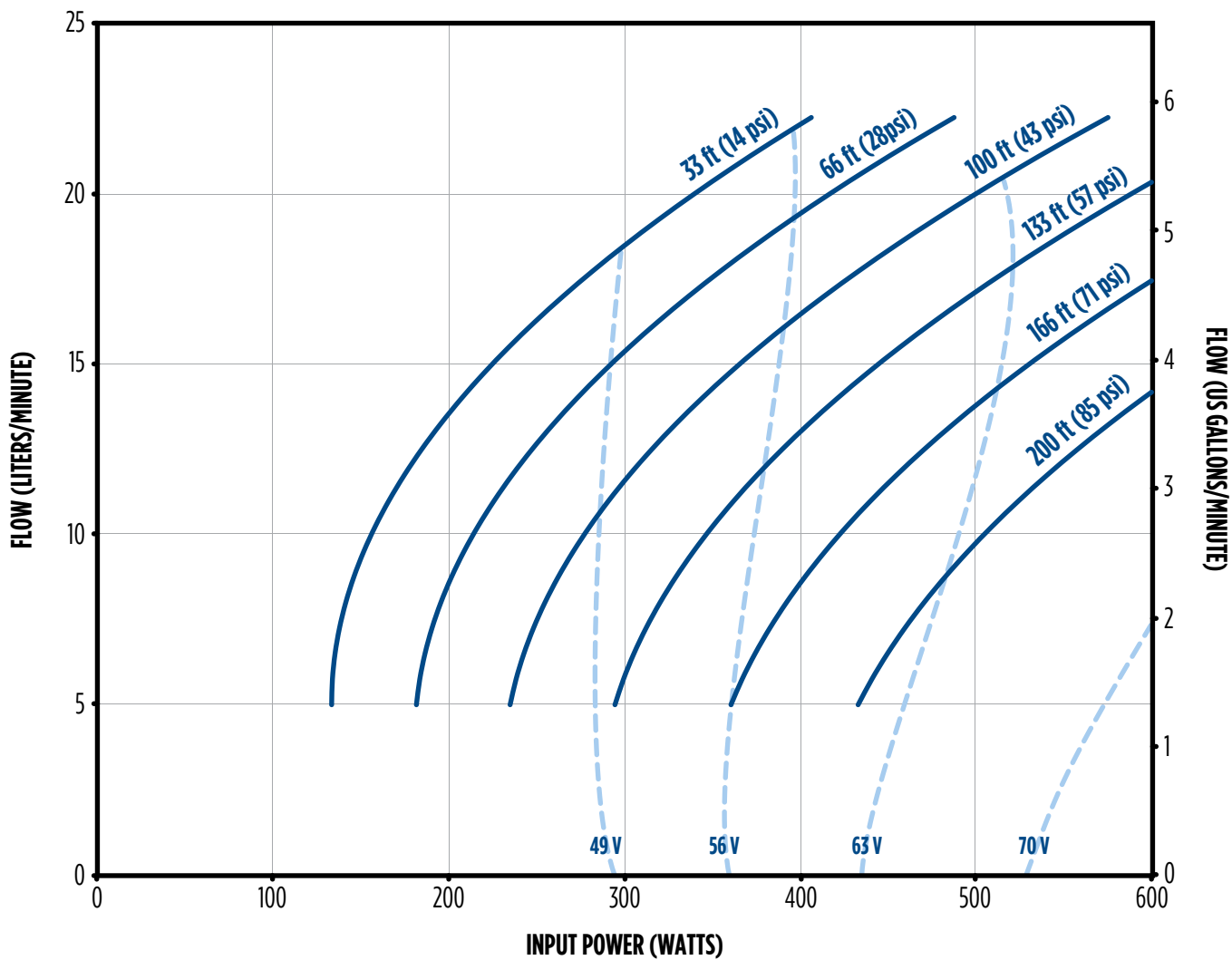



## PHOTON™ SOLARPAK - 0.5 HP (0.37 KW) PERFORMANCE

### 7FDSP-0.5HP

Photon™ Solar 0.5 hp Controller, 3200 Series 7 US gpm (25 lpm) 0.5 hp Pump End, 0.5 hp Motor

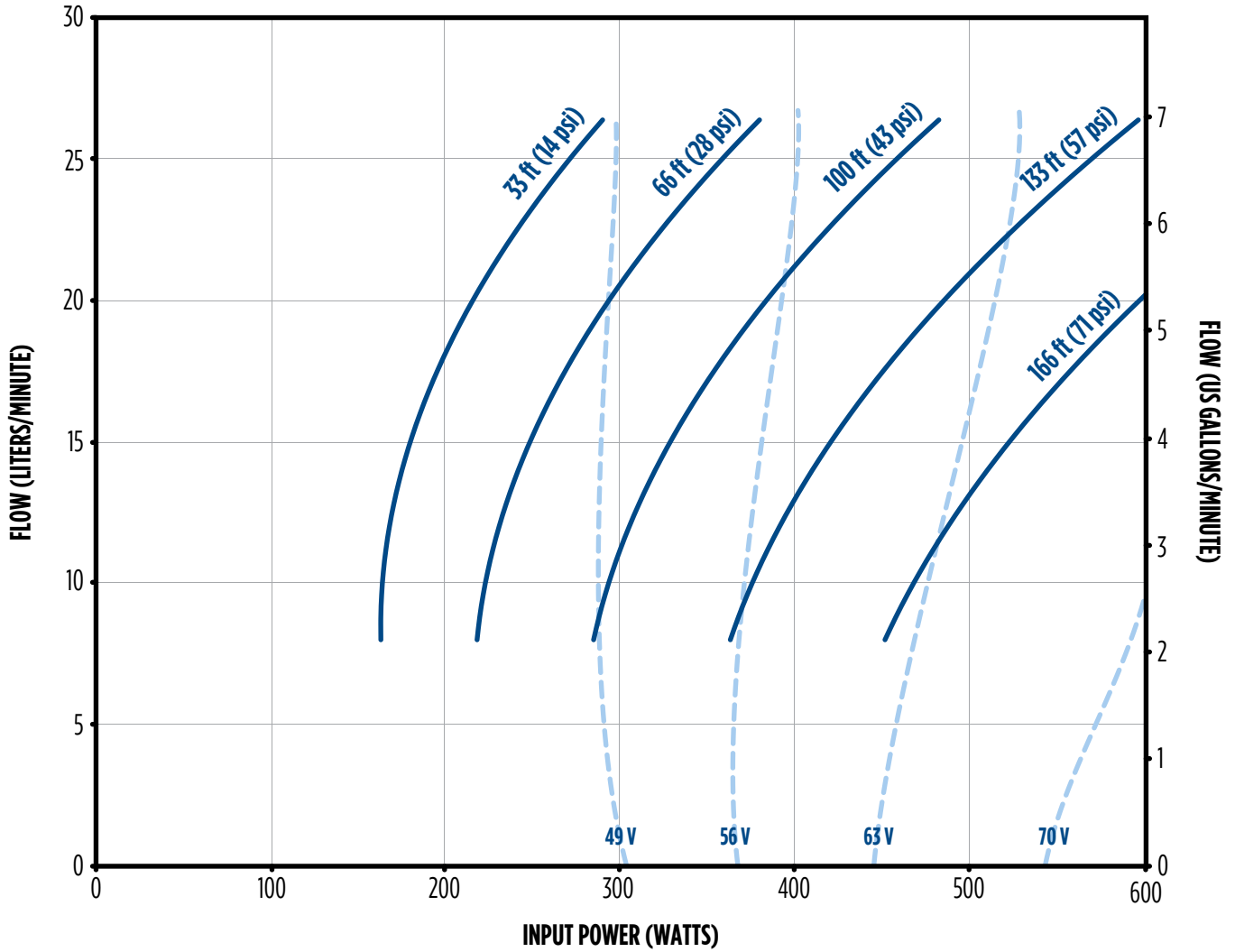

## PHOTON™ SOLARPAK - 0.5 HP (0.37 KW) PERFORMANCE

### 15FDSP-0.5HP

Photon™ Solar 0.5 hp Controller, Tri-Seal 15 gpm (45 lpm) 0.5 hp Pump End, 0.5 hp Motor

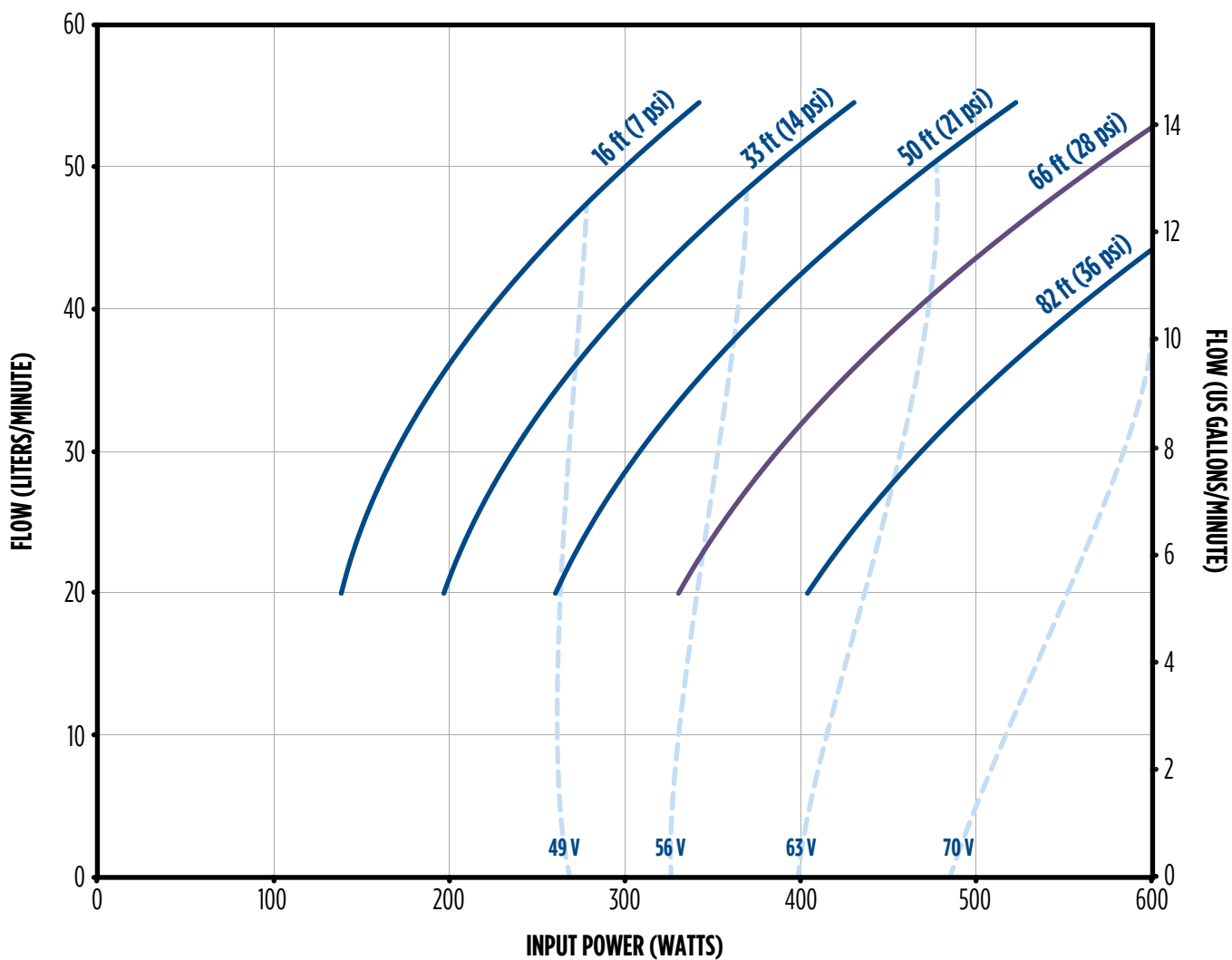

## PHOTON™ SOLARPAK - 0.5 HP (0.37 KW) PERFORMANCE

### 20FDSP-0.5HP

Photon™ Solar 0.5 hp Controller, Tri-Seal 20 US gpm (60 lpm) 0.5 hp Pump End, 0.5 hp Motor

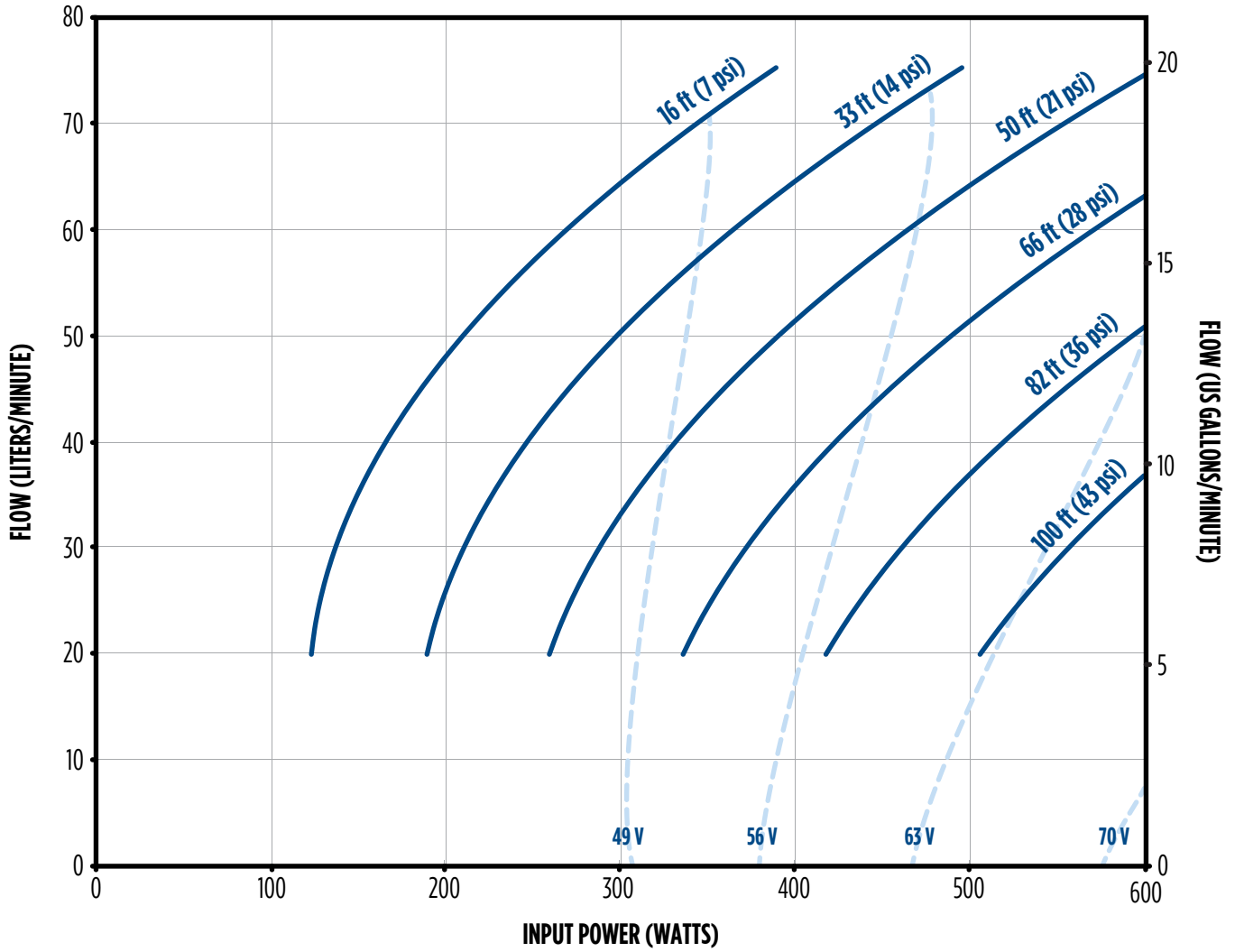

## PHOTON™ SOLARPAK - 0.75 HP (0.55 KW) PERFORMANCE

### 3FDSP-0.75HP-HR

Photon™ Solar 0.75 hp Controller, Helical Rotor 3 gpm (10 lpm) 0.75 hp Pump End, 0.75 hp Motor

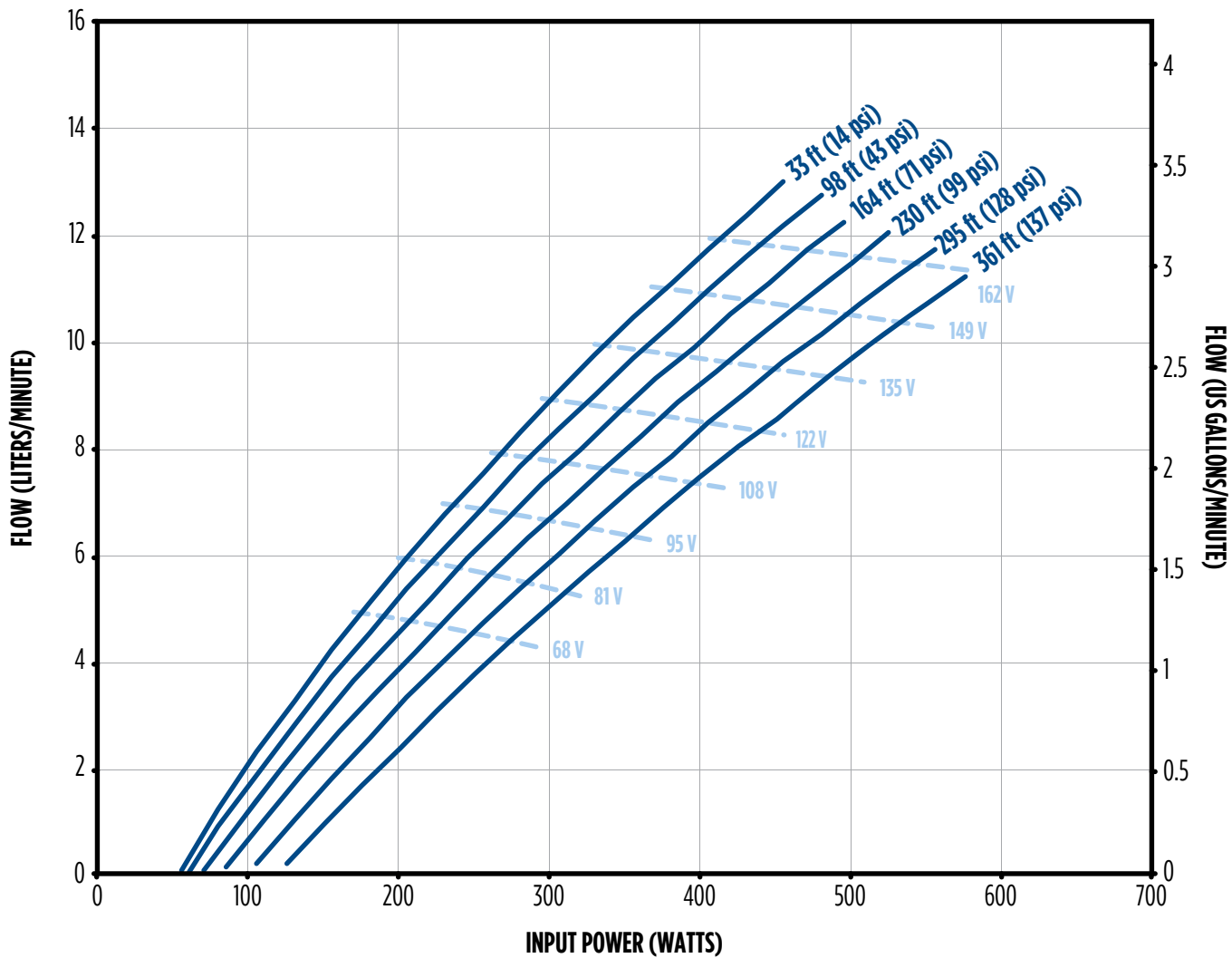

### PHOTON™ SOLARPAK - 0.75 HP (0.55 KW) PERFORMANCE

7FDSP-0.75HP-HR

Photon™ Solar 0.75 hp Controller, Helical Rotor 7 US gpm (25 lpm) 0.75 hp Pump End, 0.75 hp Motor

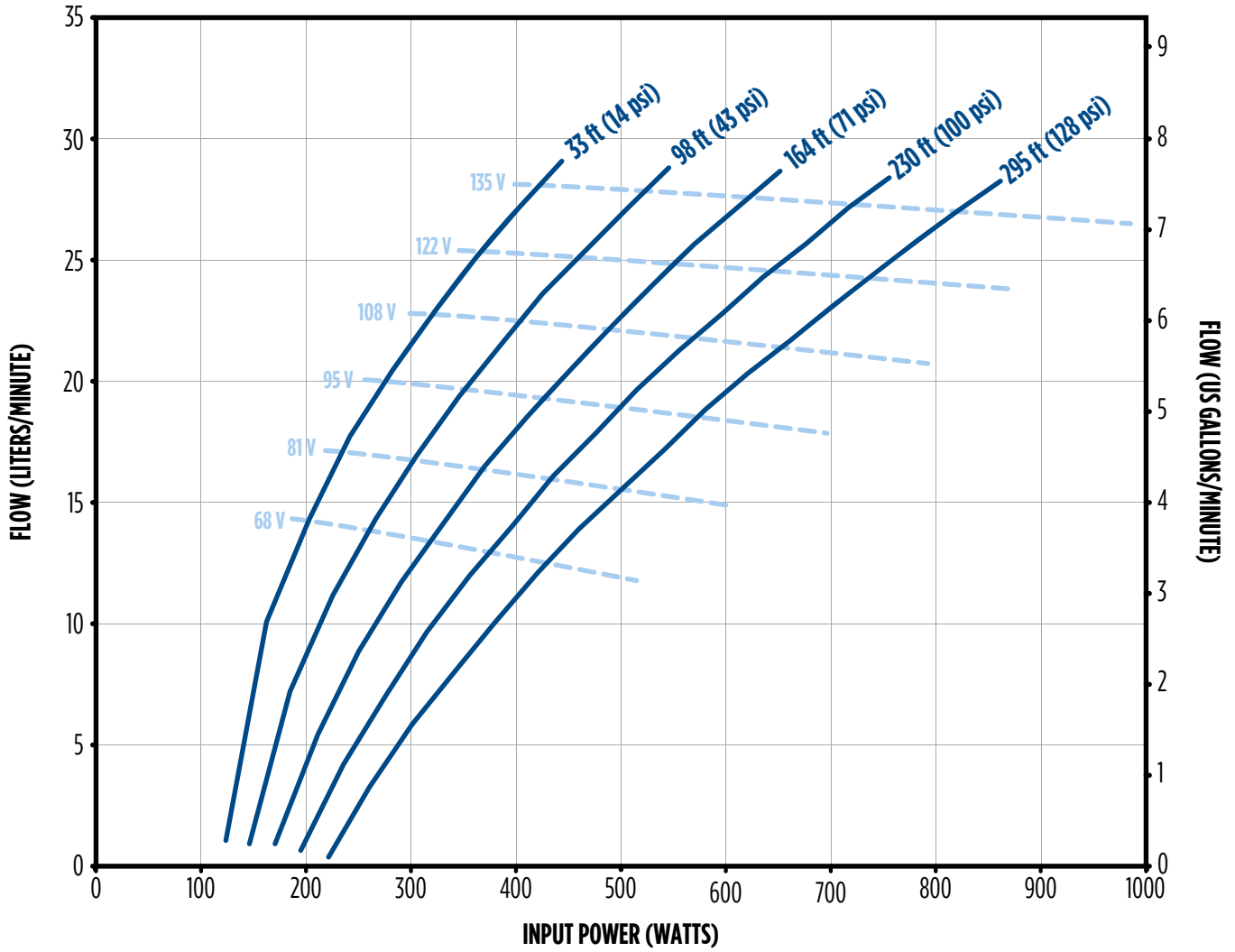

## PHOTON™ SOLARPAK - 0.75 HP (0.55 KW) PERFORMANCE

### 5FDSP-0.75HP

Photon™ Solar 0.75 hp Controller, 5 US gpm (18 lpm) 0.75 hp Pump End, 0.75 hp Motor

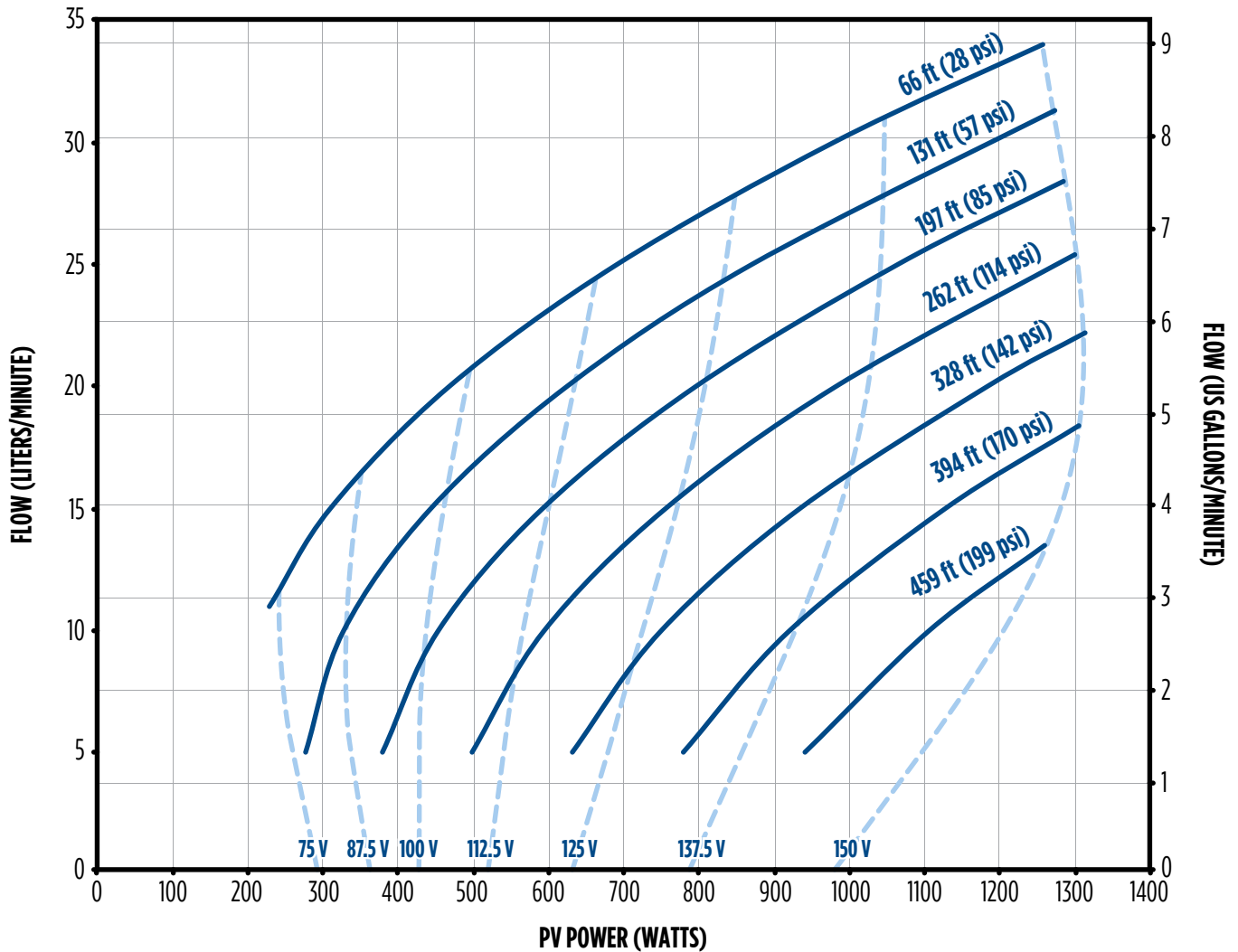

## PHOTON™ SOLARPAK - 0.75 HP (0.55 KW) PERFORMANCE

### 7FDSP-0.75HP

Photon™ Solar 0.75 hp Controller, 7 US gpm (25 lpm) 0.75 hp Pump End, 0.75 hp Motor

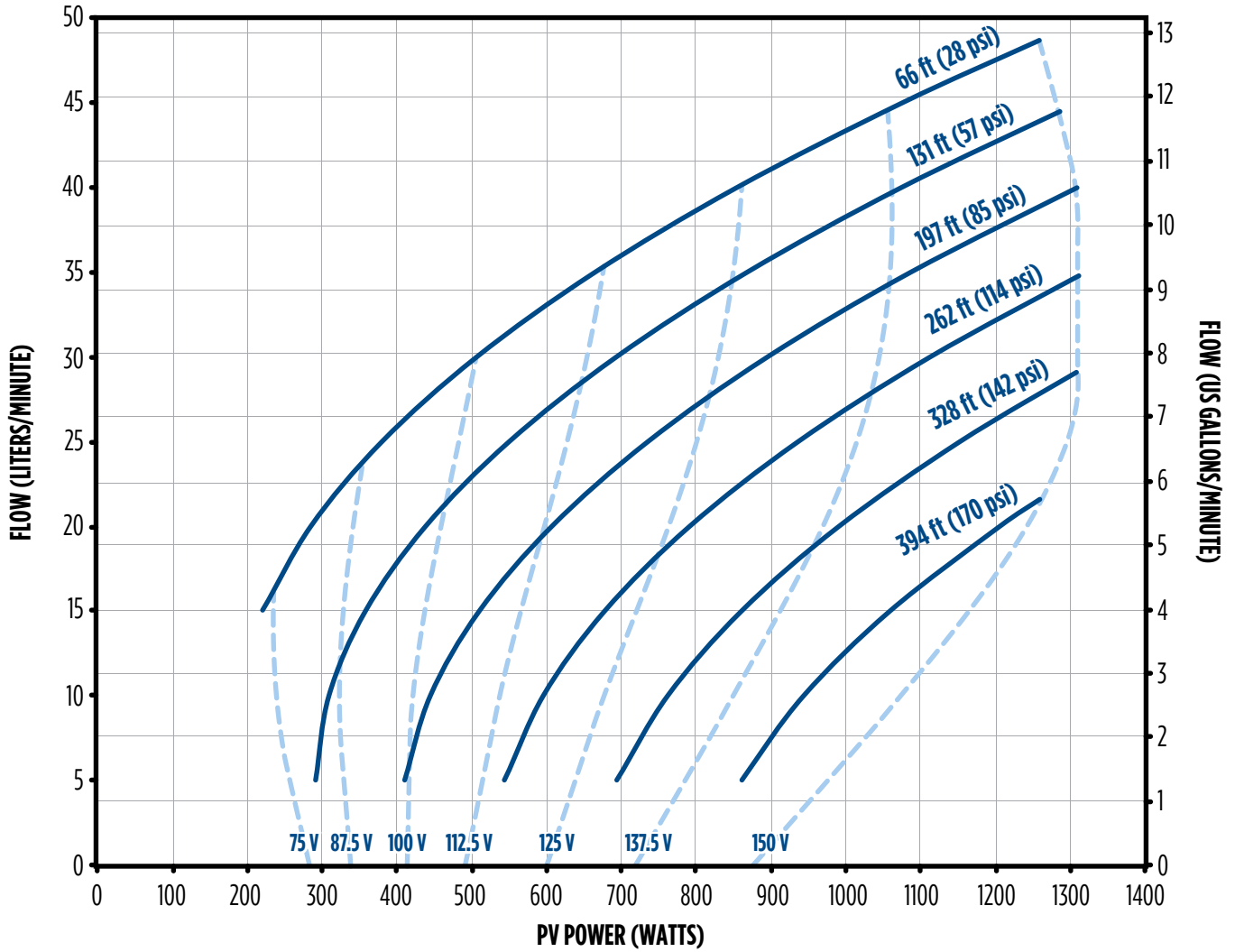

## PHOTON™ SOLARPAK - 0.75 HP (0.55 KW) PERFORMANCE

### 10FDSP-0.75HP

Photon™ Solar 0.75 hp Controller, 10 US gpm (30 lpm) 0.75 hp Pump End, 0.75 hp Motor

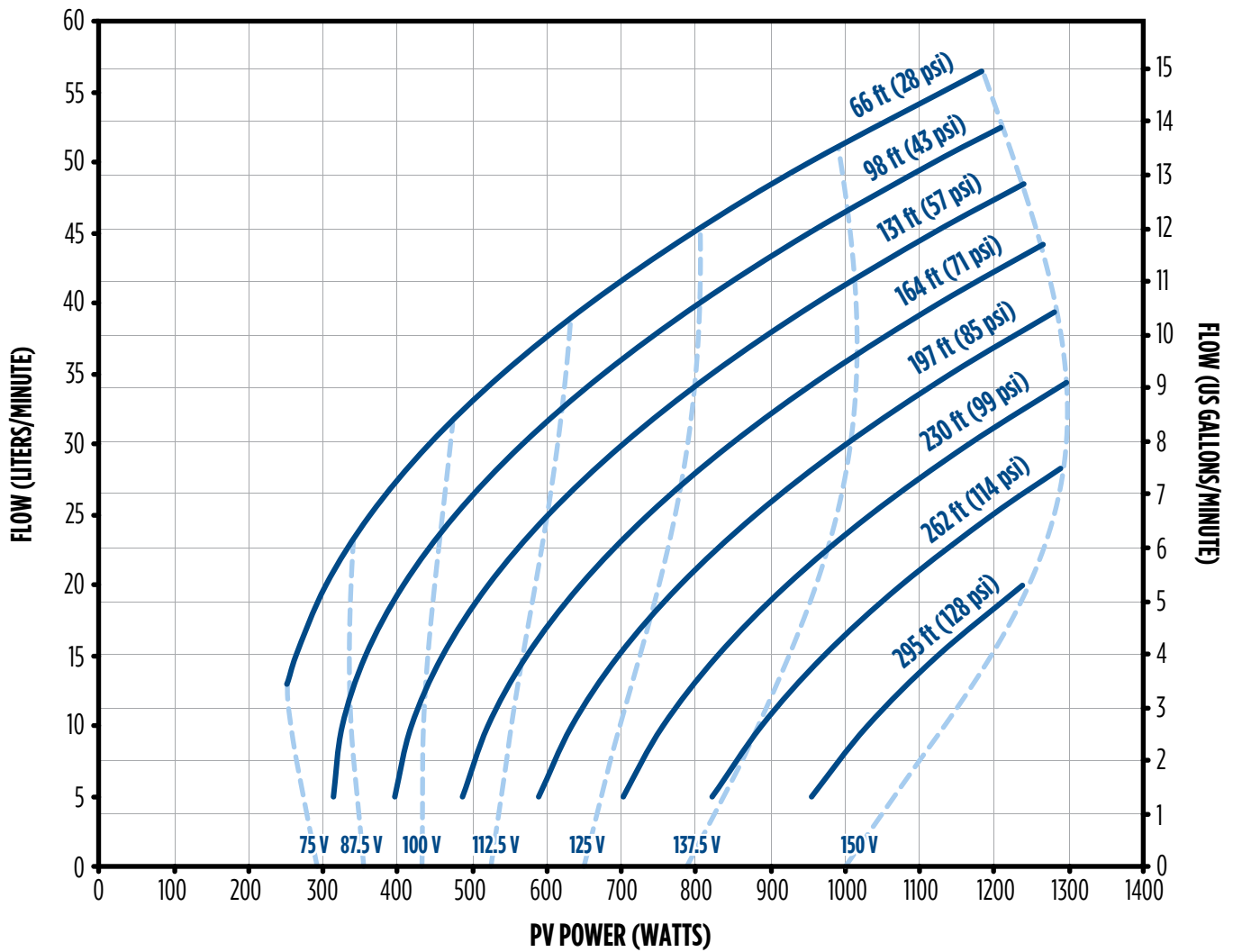



### PHOTON™ SOLARPAK - 0.75 HP (0.55 KW) PERFORMANCE

#### 15FDSP-0.75HP

Photon™ Solar 0.75 hp Controller, 15 US gpm (45 lpm) 0.75 hp Pump End, 0.75 hp Motor

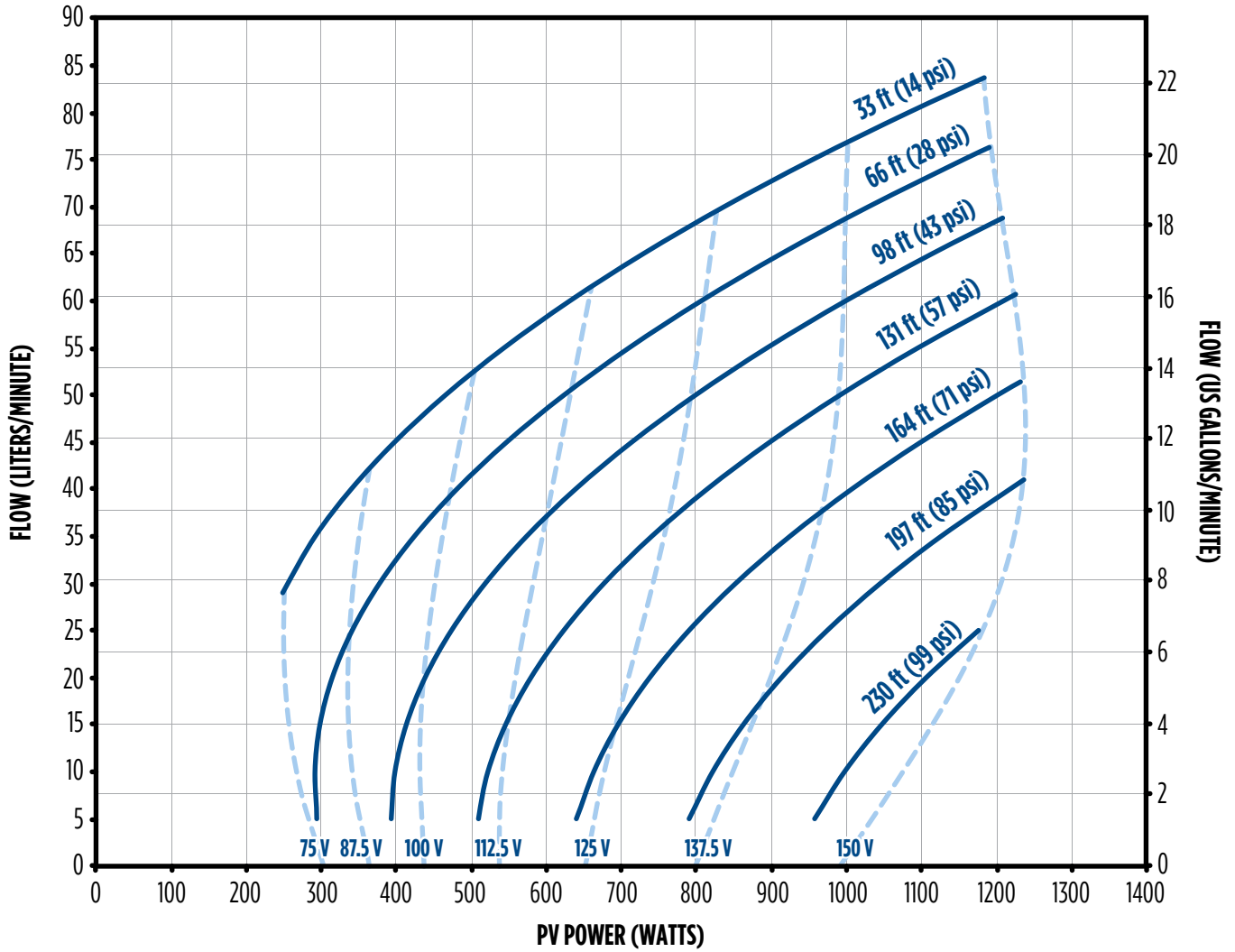

# PHOTON™ SOLARPAK - 1.5 HP (1.1 KW) PERFORMANCE

## 5FDSP-1.5HP

Photon™ Solar 1.5 hp Controller, 5 US gpm (18 lpm) 1.5 hp Pump End, 1.5 hp Motor

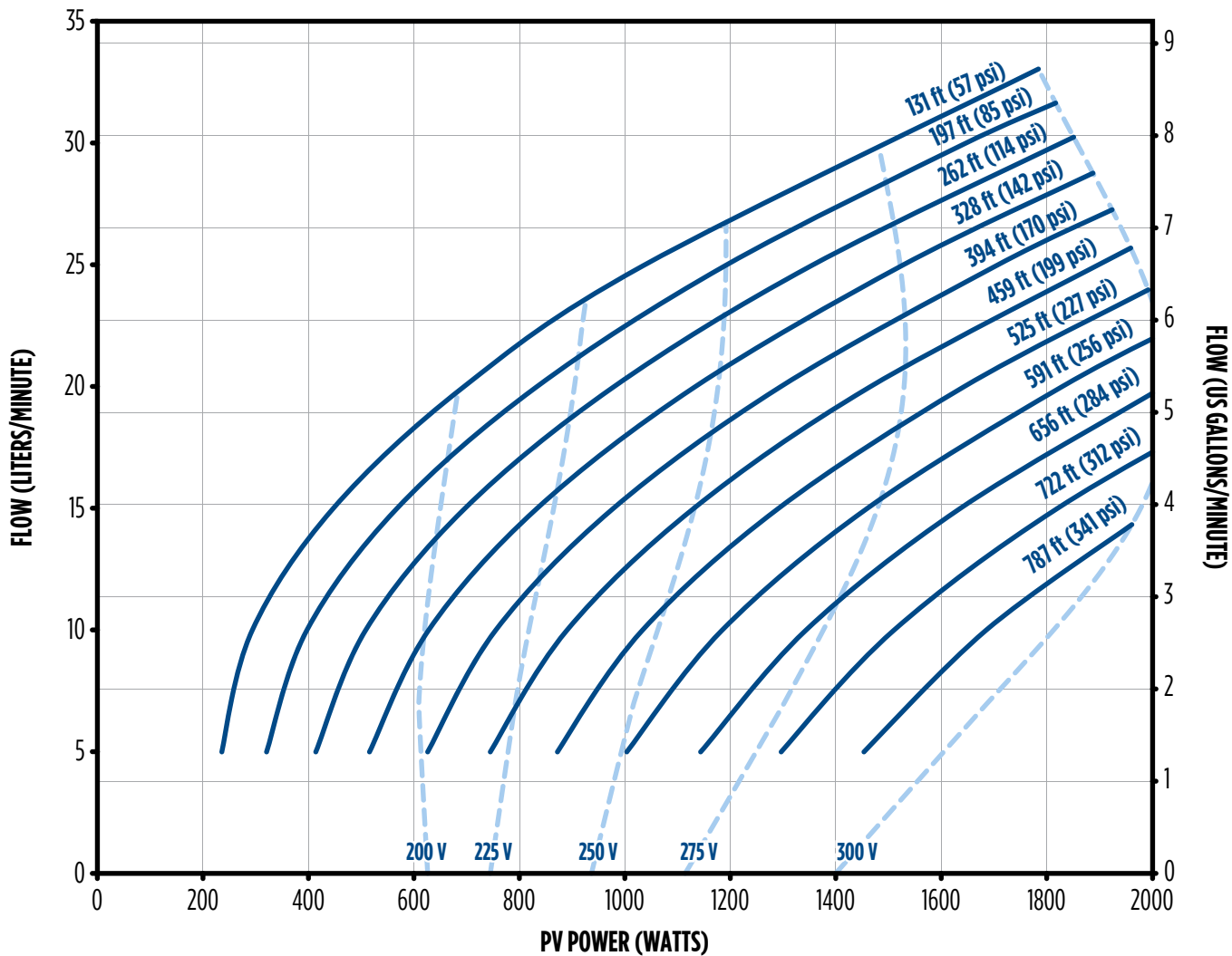

### PHOTON™ SOLARPAK - 1.5 HP (1.1 KW) PERFORMANCE

#### 7FDSP-1.5HP

Photon™ Solar 1.5 hp Controller, 7 US gpm (25 lpm) 2.0 hp Pump End, 1.5 hp Motor

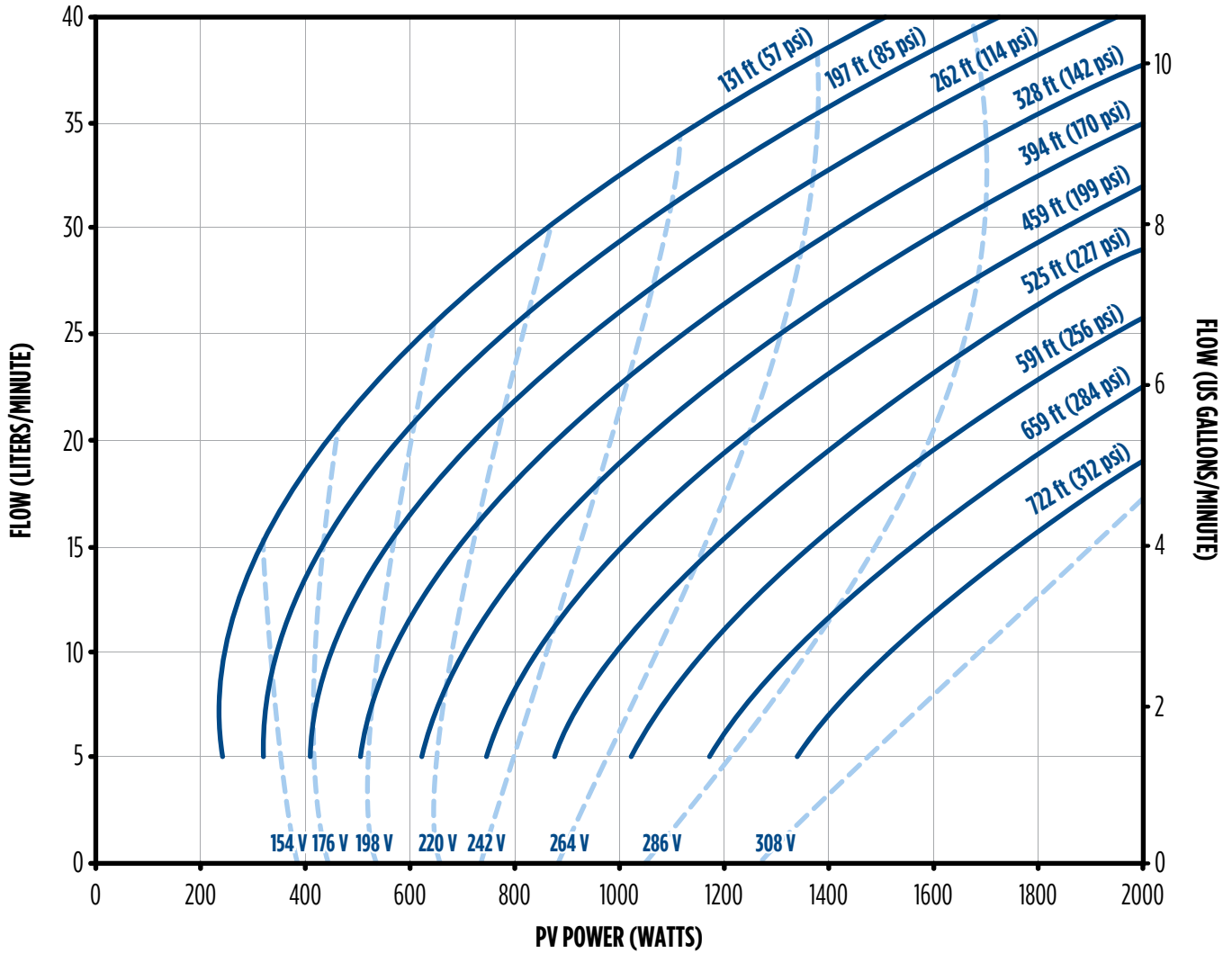

# PHOTON™ SOLARPAK - 1.5 HP (1.1 KW) PERFORMANCE

## 10FDSP-1.5HP

Photon™ Solar 1.5 hp Controller, 10 US gpm (30 lpm) 2.0 hp Pump End, 1.5 hp Motor

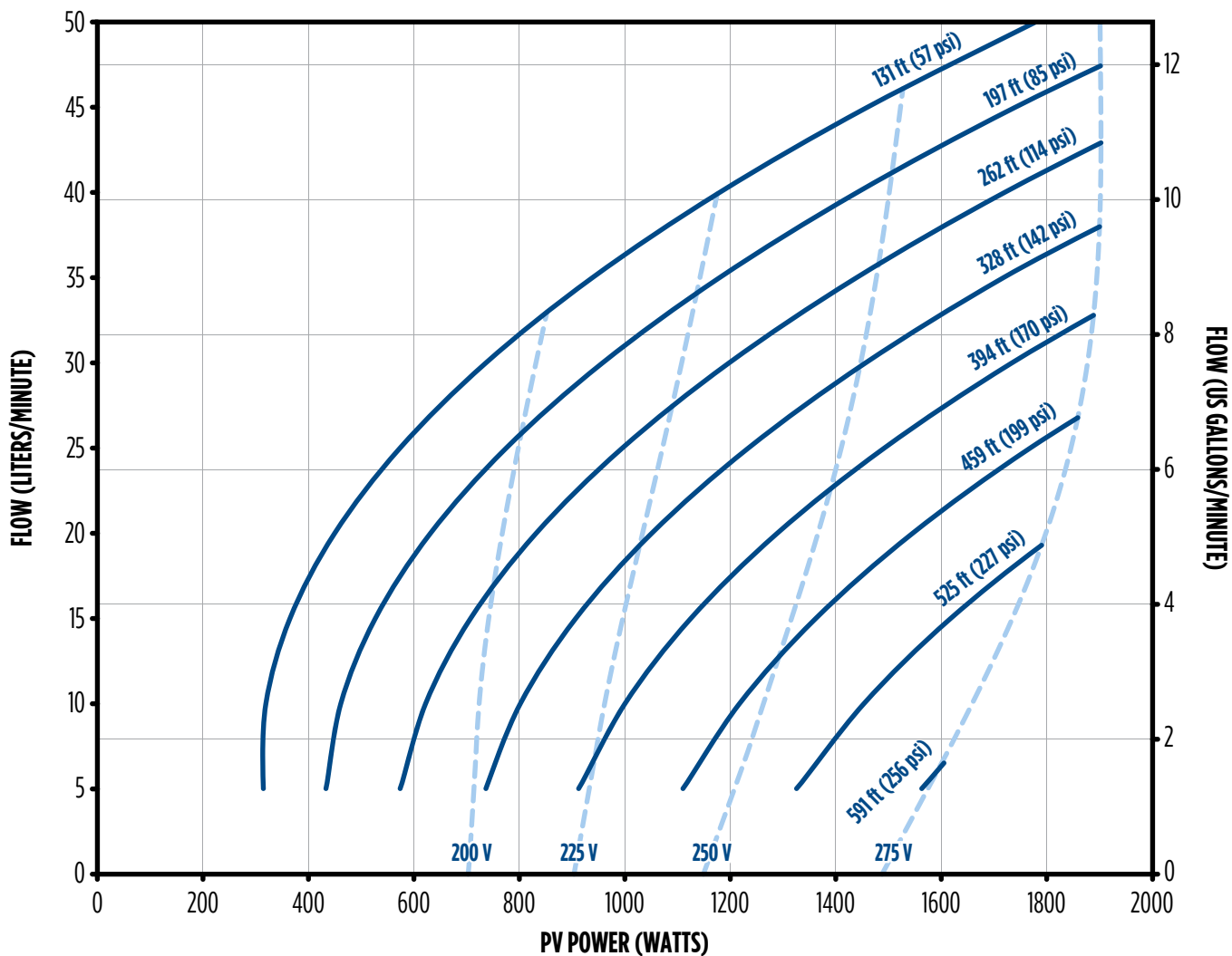

### PHOTON™ SOLARPAK - 1.5 HP (1.1 KW) PERFORMANCE

#### 15FDSP-1.5HP

Photon™ Solar 1.5 hp Controller, 15 US gpm (45 lpm) 2.0 hp Pump End, 1.5 hp Motor

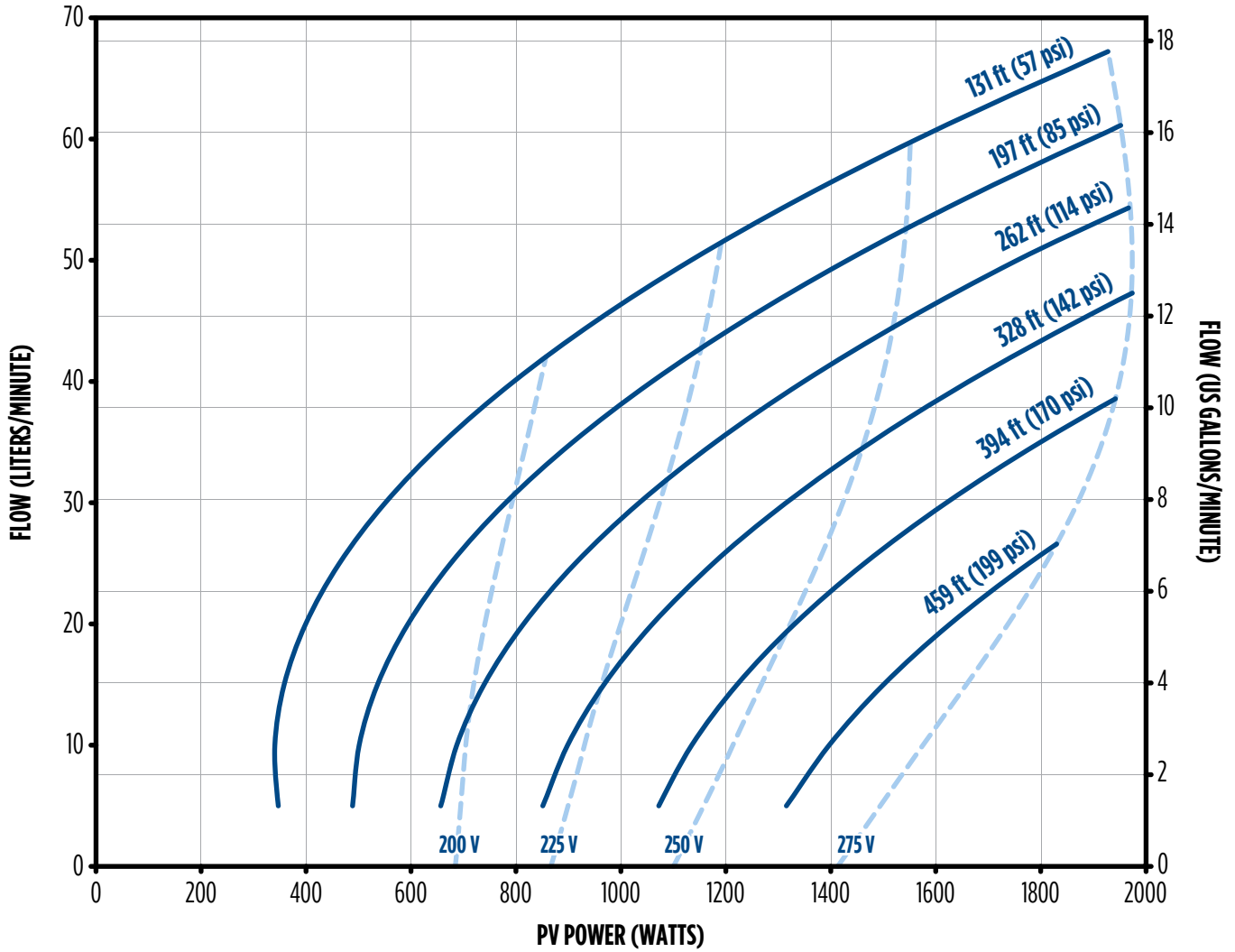

# PHOTON™ SOLARPAK - 1.5 HP (1.1 KW) PERFORMANCE

## 25FDSP-1.5HP

Photon™ Solar 1.5 hp Controller, 25 US gpm (70 lpm) 2.0 hp Pump End, 1.5 hp Motor

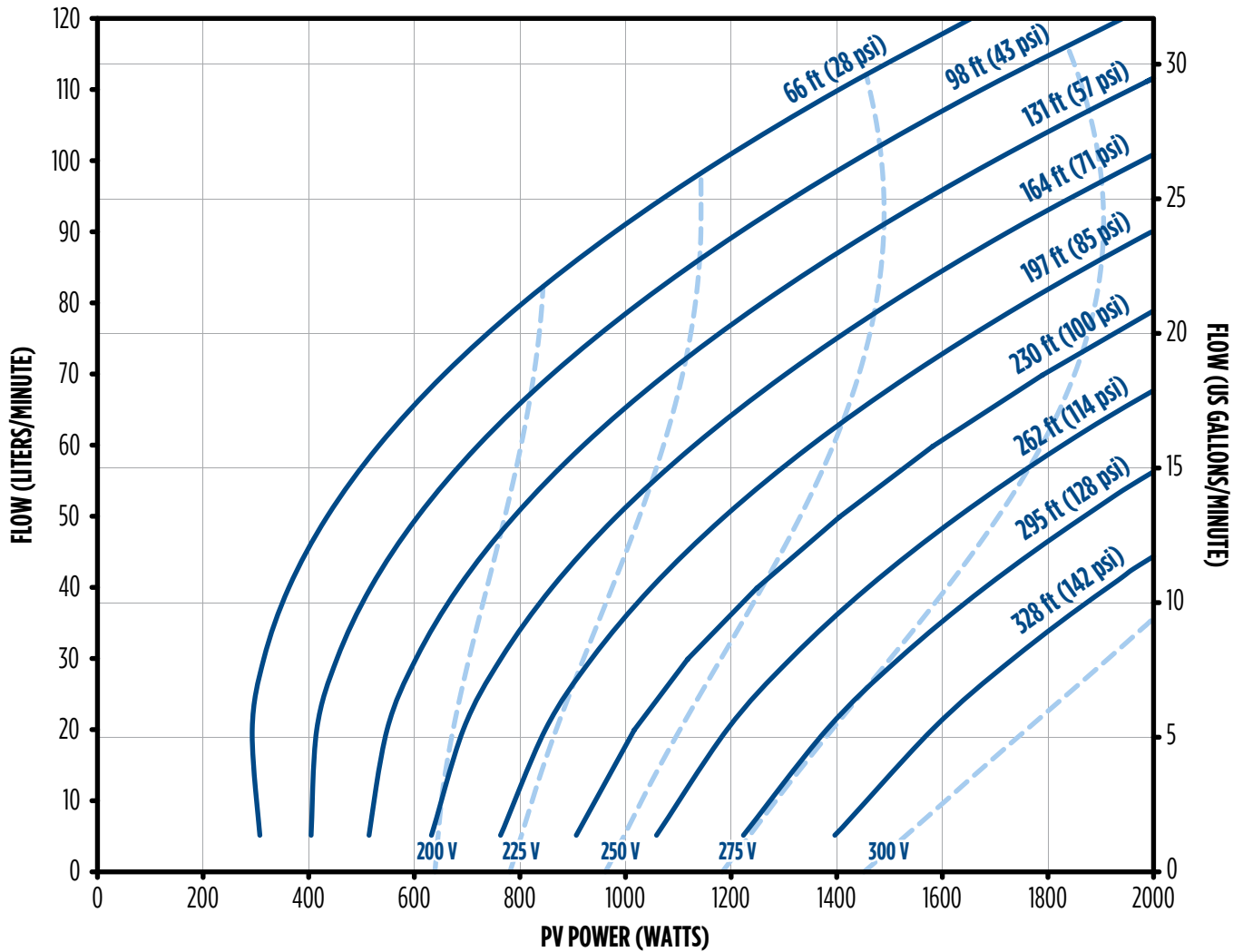

# PHOTON™ SOLARPAK - 1.5 HP (1.1 KW) PERFORMANCE

## 35FDSP-1.5HP

Photon™ Solar 1.5 hp Controller, 35 US gpm (100 lpm) 2.0 hp Pump End, 1.5 hp Motor

Basic Model	PEI <sub>CL</sub> Number
35S4	0.83

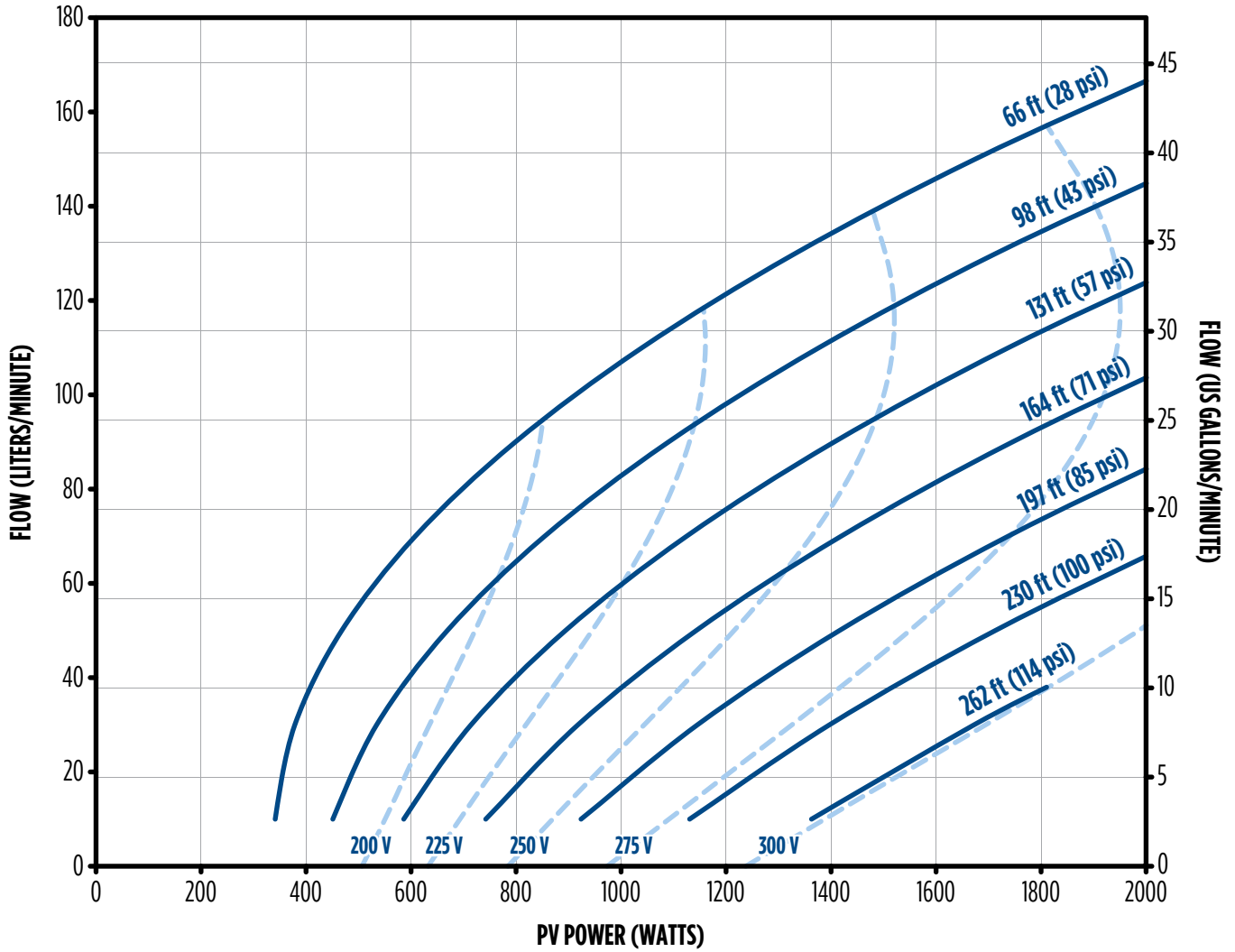

# PHOTON™ SOLARPAK - 1.5 HP (1.1 KW) PERFORMANCE

## 45FDSP-1.5HP

Photon™ Solar 1.5 hp Controller, 45 US gpm (150 lpm) 2.0 hp Pump End, 1.5 hp Motor

Basic Model	PEI <sub>1</sub> Number
45S4	0.89

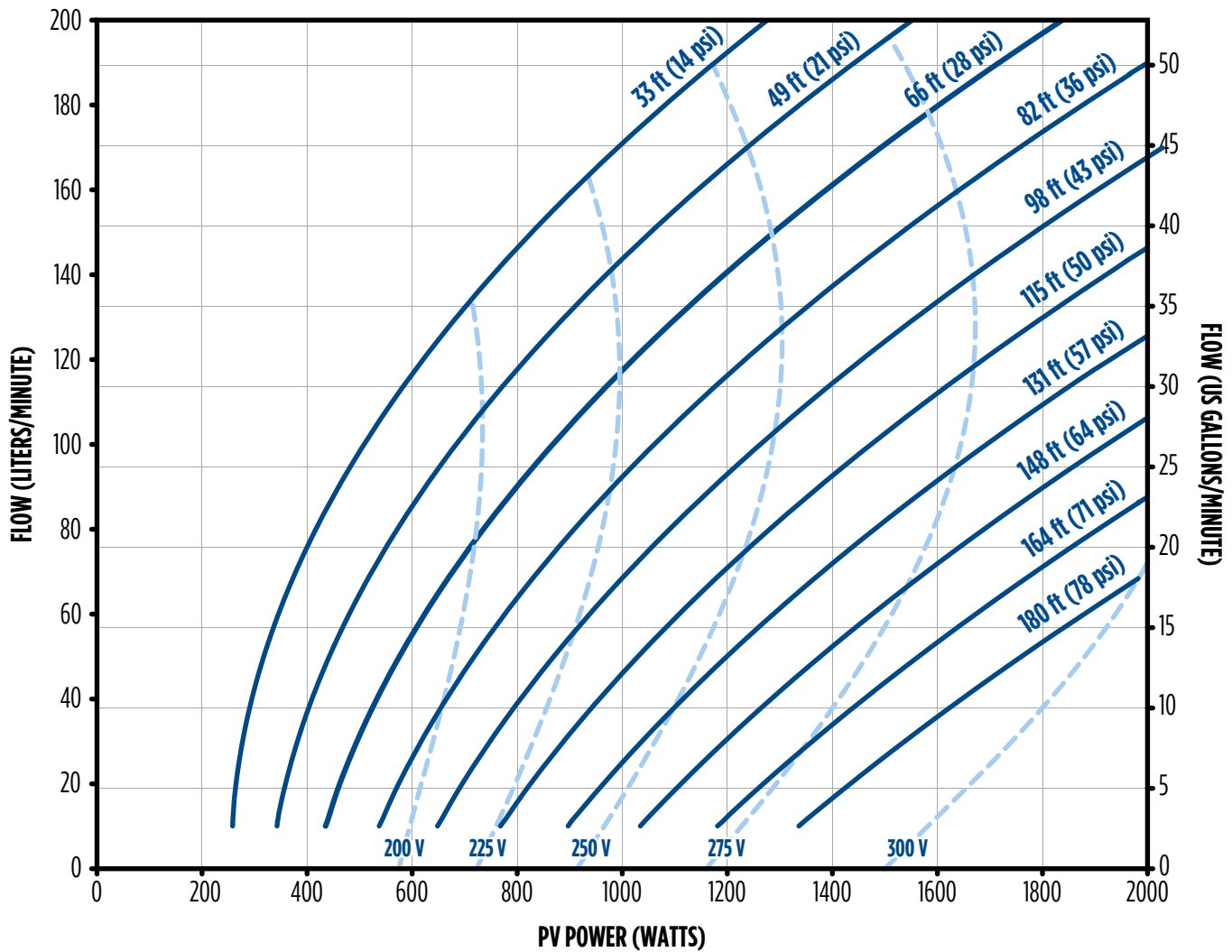



### PHOTON™ SOLARPAK - 1.5 HP (1.1 KW) PERFORMANCE

90FDSP-1.5HP

Photon™ Solar 1.5 hp Controller, 90 US gpm (270 lpm) 2.0 hp Pump End, 1.5 hp Motor

Basic Model	PEI <sub>CL</sub> Number
90S4	0.92

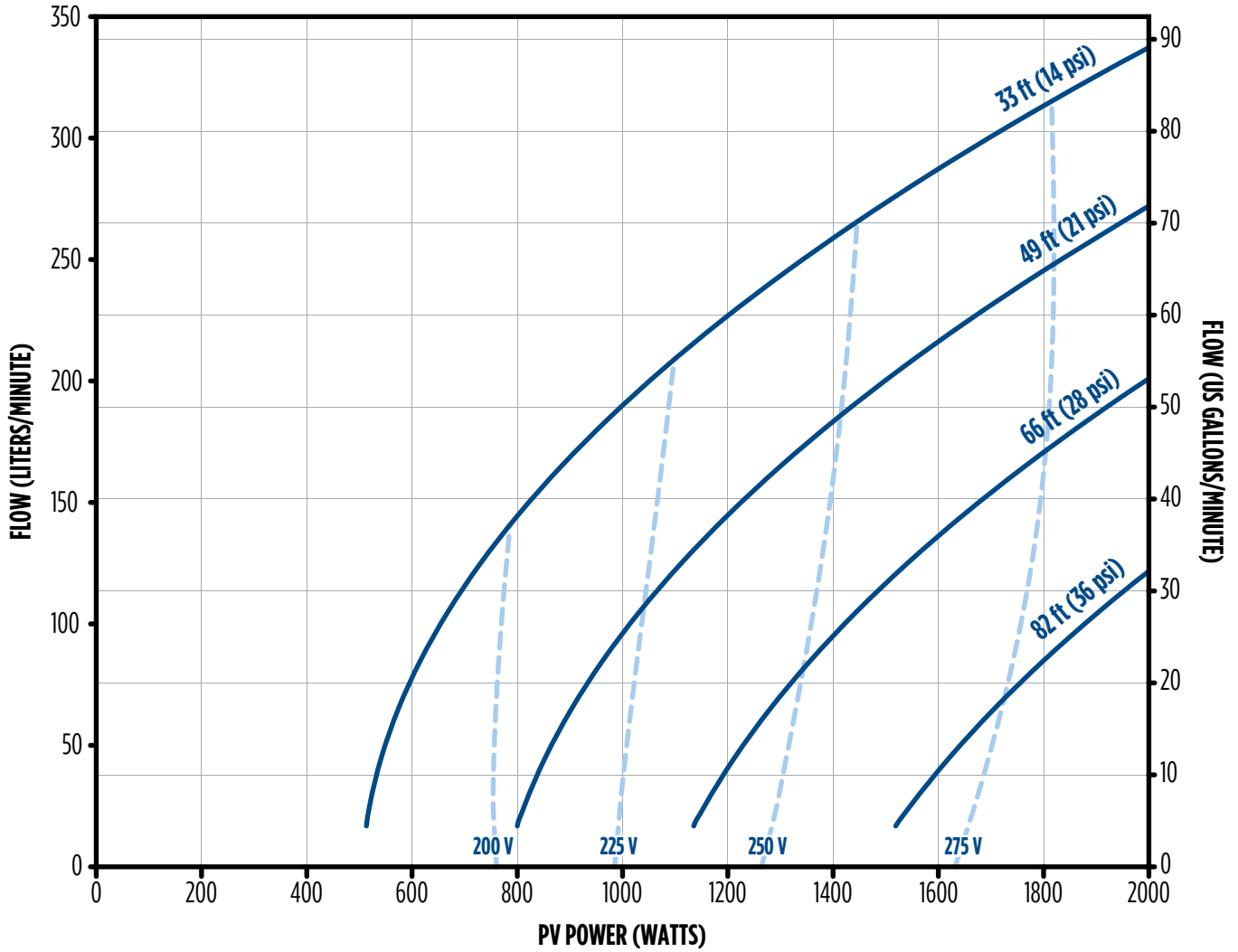

## PHOTON™ SOLARPAK - DIMENSIONS

### SOLAR PMA DIMENSIONS

System			Pump End			PMA								
HP	US GPM	Stages	HP	Weight		Discharge (in)	Weight		A		B		C	
				lbs	kg		lbs	kg	in	mm	in	mm	in	mm
0.5	5	13	0.5	10	4.5	1-1/4	28	12.7	18.4	467	9.5	242	27.9	709
	7	10		9	4.1		27	12.3	15.9	404	9.5	242	25.4	646
	15	4		7	3.2		25	11.4	10.6	270	9.5	242	20.1	511
	20	4		9	3.9		27	12.3	14.3	364	9.5	242	23.8	605
0.75	3*	-	0.75	10	4.5	1-1/4	31	14.1	24.8	630	10.64	270	35.5	900
	7*	-		12	5.5		33	15.0	24.8	630	10.64	270	35.5	900
	5	18		12	5.5		33	15.0	22.6	574	10.64	270	33.2	844
	7	13		11	5.0		32	15.0	18.4	467	10.64	270	29.0	737
	10	8		10	4.5		31	14.0	14.1	359	10.64	270	24.8	629
	15	6		9	4.1		30	14.0	12.4	315	10.64	270	23.0	585
1.5	5	38	2	23	10	1-1/4	52	24	40.9	1039	11.7	298	52.6	1336
	7	30		20	9		49	22	34.1	866	11.73	298	45.8	1164
	10	18		15	7		44	20	25.3	643	11.73	298	37.0	941
	15	14		13	6		42	19	19.57	497	11.73	298	31.3	795
	25	10		11	5		40	18	19.2	488	11.73	298	30.9	786
	35	9		10	5		39	18	17	431	11.73	298	28.7	728
	45	7		9	4	38	17	17.6	447	11.73	298	29.3	744	
	90	6		10	5	39	18	23.4	594	11.73	298	35.1	892	

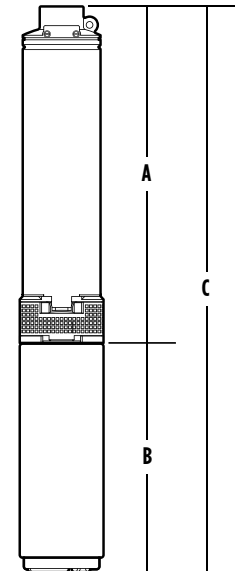

NOTE: Diameter with cable guard 3.75" (95.3 mm) for 5 & 7gpm pumps; all others 3.90" (99.1 mm).  
 High capacity pumps, 35 US gpm (100 lpm) and higher, in a SolarPAK are not supplied with an internal check valve.  
 \* Photon™ HR Models

### SOLAR CONTROLLER DIMENSIONS

Dimensions	A	B	C	D	E	F	G1	G2	G3	G4	G5
Inches	8.17	6.28	6.10	4.88	7.40	6.28	7.32	3.30	1.38	1.38	4.94
Millimeters	207.52	159.50	155.00	124.00	188.00	159.50	185.93	83.82	35.00	35.00	125.48

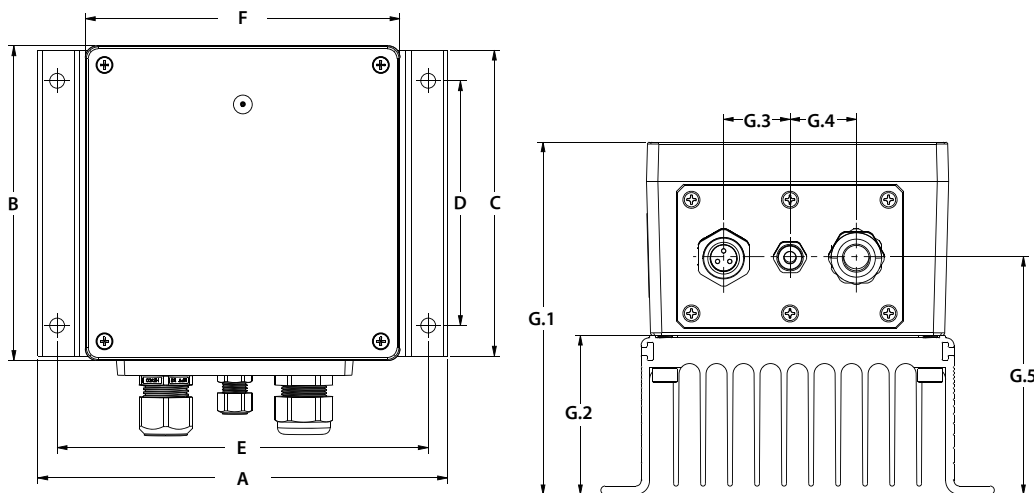

### HR SOLAR CONTROLLER DIMENSIONS

Photon™ Solar Controller	For use with pump	Motor rating	Input Voltage	Controller size, in (mm)		
				L	W	D
581013000864-SPIP000	HR 3 gpm 3/4 hp (10 lpm 0.55 kW)	3/4 hp (0.55 kW), 100 V 60 Hz 3 ph	45-300 V DC	6.28 (159.5)	6.28 (159.5)	7.32 (185.93)
581013000864-SPIP001	HR 7 gpm 3/4 hp (25 lpm 0.55 kW)					

## PHOTON™ SOLARPAK - DRIVE SPECIFICATIONS

### SOLAR CONTROLLER

	0.5 hp (0.37 kW) Model	0.75 hp (0.55 kW) Model	1.5 hp (1.1 kW) Model
Controller Model No.	581011100984-SP050HP	581013000864-SP075HP	581014200864-SP150HP
<b>Output</b>			
Max. Output Voltage	48 V AC, 3-phase	100 V AC, 3-phase	200 V AC, 3-phase
Max. Amps (RMS)	9.8 A, each phase	8.6 A, each phase	6.8 A, each phase
Output Frequency	20-60 Hz		
Efficiency at Max Power	98% (Approx.)		
<b>PV Source</b>			
Input Voltage	40* – **110 V DC	*45 – **300 V DC	*115 – **420 V DC
Max. Amps Input	7.2 A DC, continuous	7.2 A DC, continuous	6.2 A DC, continuous
Power at MPP	Up to 0.38 kW	Up to 1200 Watts	Up to 2000 Watts
<b>For Use With</b>			
Franklin Electric Motor	2349049204G	234902----	234504----
<b>Controller Size - L x W x D</b>			
in (mm)	6.28 x 6.28 x 7.32 (159.5 x 159.5 x 185.9)		
<b>Controller Weight</b>			
lbs (kg)	10 (4.5)		
<b>Operating Conditions</b>			
Temperature Range	-13 °F to 122 °F / -25 °C to 50 °C		
Relative Humidity Range	0 to 100% Condensing		
Enclosure Rating	NEMA 4		

\* Low V DC limit should not be interpreted as an adequate rated PV array output voltage for any installation. See the PV Solar Array Specifications and system sizing program for indication of adequate array voltage to provide useful pumping capability.

\*\* Absolute maximum open circuit voltage input to the controller - 300 VOC for 581013000864-SP075HP and 420 VOC for 581014200864-SP150HP

## FHOTON™ SOLARPAK (5–10 HP, 3.7–7.5 kW)

The Fhoton™ SolarPAK is the system solution to your solar pumping requirements. By utilizing quality components, innovative thinking based on global market inputs, and a technical expertise in groundwater pumping, Franklin Electric has developed a rugged, high-output system that tackles the challenges of harsh and remote environments. No other system delivers the features, benefits, and reliability in just one package!

### FEATURES

- High-flow system for faster tank-fill and significant water output
- Proven motor and pump technology for long-term reliability
- Patented software provides enhanced dry-run protection
- Robust IP66, NEMA 4 enclosure minimizes impact from wildlife, insects, dust, and weather
- Operating status and fault conditions indicated by multi-color LED
- Increased performance flexibility compatible with a wider range of input voltages (up to 850 VDC)
- Terminals provided for an optional data communications board using the FE Connect App
- Maximum Power Point Tracking (MPPT) for maximizing efficiency of input power
- Soft-start feature prevents water hammer and increases system life
- Simple installation with no required maintenance
- Built-in diagnostics and protection
- cULus and UL approved

### SOLARPAK CONTENTS

- Franklin Electric 4" and 6" submersible motors
  - Motor and drive ratings available: 5.0–10 hp (5.4 - 10.6 kW)
- Franklin Electric 4" and 6" submersible pumps
  - Variety of flow rates available: 10, 15, 25, 35, 45, 60, 90, 100, 125, 150, 180, 220, 275, 325, or 375 US gpm
- Fhoton™ solar controller
- Flow switch with 30 ft (10 m) cable

### SOLARPAK NOMENCLATURE

**XXX FD SP - X.XHP**

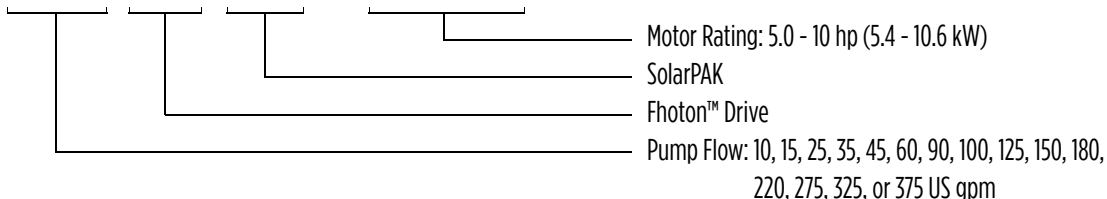

## PHOTON™ SOLARPAK (5–10 HP, 3.7–7.5 KW)

### COMPONENTS

IP56/NEMA 4 enclosure for indoor/outdoor use

Operating status indicated by multi-color LED

Jumper section for single- or two-level control

Contacts for up to two-level control switches (can also operate from a pressure switch)

DC power supply input from the solar array

Removable bottom gland plate for simple conduit installation

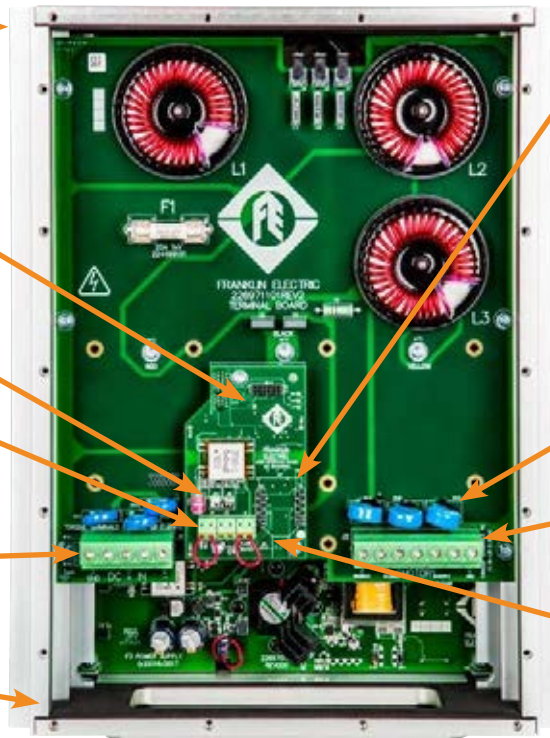

Terminals provided for optional data communications board through use of Photon™ FE Connect App



MOVs for additional lightning protection

Output connections for 230/380 V, 3-phase FE motors allowing for lower voltage needs from solar array

Flow switch input to detect dry-run conditions for additional motor and pump protection

### APPLICATIONS

The Photon™ drive supports submersible pumping applications:

- Livestock watering
- Tank/Cistern filling
- Wildlife refuge and game farms
- Rural water supply for villages and homesteads
- Irrigation systems
- Fountains
- Vineyards
- Renewable energy projects
- Effluent pumping
- Rain harvesting

### BUILT-IN DIAGNOSTICS & PROTECTION

The Photon™ SolarPAK includes diagnostic features and built-in protection from potential harmful conditions, including:

- Surge
- Underload/Dry run
- Overvoltage
- Locked pump
- Open circuit
- Short circuit
- Overheated controller
- Reverse polarity
- Deadhead



## PHOTON™ SOLARPAK - ORDERING INFORMATION

### SOLARPAK MODEL NUMBERS (NPT)

SolarPak		Photon™ Solar Controller		Solar Pump (NPT)						Motor			
Model	Order No.	Drive Model	Part. No.	US GPM	Pump Line	Solar Pump	Part No.	Basic Model	PEI <sub>CL</sub> Number	HP	Volts	Dia.	Part No.
10FDSP-5HP	90041054	F3, 5 hp, 230VAC, 60 Hz, 4"	581038501994-SPIS000	10	4" Tri-Seal	10FA5S4-PE	93821035	-	-	5	230	4"	2343178602G
15FDSP-5HP	90041554			15	4" Tri-Seal	15FA5S4-PE	93821535	-	-				
25FDSP-5HP	90042554			25	4" Tri-Seal	25FA5S4-PE	93822535	-	-				
35FDSP-5HP	90043554			35	4" High Cap	35FH5S4-PE	93653512*	35S4	0.83				
45FDSP-5HP	90044554			45	4" High Cap	45FH5S4-PE	93654516*	45S4	0.89				
60FDSP-5HP	90046054			60	4" High Cap	60FH5S4-PE	93656016*	60S4	0.94				
90FDSP-5HP	90049054			90	4" High Cap	90FH5S4-PE	93659013*	90S4	0.92				
100FDSP-5HP	90040154			100	6" High Cap	100FH5S6-PE	93650003*	100S6	-				
125FDSP-5HP	90041254			125	6" High Cap	125FH5S6-PE	93652502*	125S6	-				
150FDSP-5HP	90040254			150	5" STS Turbine	150STS5D5A-0243	97050150002*	-	-				
180FDSP-5HP	90041854			180	5" STS Turbine	180STS5D5X-0344	97050180003*	-	-				
220FDSP-5HP	90042254			220	5" STS Turbine	220STS5D5A-0244	97050220002*	-	-				
275FDSP-5HP	90042754	F3, 5 hp, 230VAC, 60 Hz, 6"	581038501994-SPIS006	275	6" STS Turbine	275STS5D6A-0164	97060275001*	-	-	5	230	6"	2366008120
325FSP-5HP	90043254			325	6" STS Turbine	325STS5D6C-0264	97060325202*	-	-				
375FDSP-5HP	90043754			375	6" STS Turbine	375STS5D6A-0164	97060375001*	-	-				
20FDSP-7.5HP	90042074	F3, 7.5 hp, 380VAC, 60 Hz, 4"	581038501994-SPIS009	20	4" Tri-Seal	20FA7S4-PE	93822040	-	-	7.5	380	4"	2343488602G
25FDSP-7.5HP	90042574			25	4" Tri-Seal	25FA7S4-PE	93822540	-	-				
35FDSP-7.5HP	90043574			35	4" High Cap	35FH7S4-PE	93653529*	35S4	0.83				
45FDSP-7.5HP	90044574			45	4" High Cap	45FH7S4-PE	93654523*	45S4	0.89				
60FDSP-7.5HP	90046074			60	4" High Cap	60FH7S4-PE	93656023*	60S4	0.94				
90FDSP-7.5HP	90049074			90	4" High Cap	90FH7S4-PE	93659019*	90S4	0.92				
100FDSP-7.5HP	90040174			100	6" High Cap	100FH7S6-PE	93650005*	100S6	-				
125FDSP-7.5HP	90041274			125	6" High Cap	125FH7S6-PE	93652504*	125S6	-				
150FDSP-7.5HP	90040274			150	5" STS Turbine	150STS7D5A-0343	97050150003*	-	-				
180FDSP-7.5HP	90041874			180	5" STS Turbine	180STS7D5X-0444	97050180004*	-	-				
220FDSP-7.5HP	90042274			220	5" STS Turbine	220STS7D5X-0444	97050220004*	-	-				
275FDSP-7.5HP	90042774			F3, 7.5 hp, 380VAC, 60 Hz, 6"	581038501994-SPIS004	275	6" STS Turbine	275STS7D6X-0264	97060275002*				
325FSP-7.5HP	90043274	325	6" STS Turbine			325STS7D6X-0264	97060325202*	-	-				
375FDSP-7.5HP	90043774	375	6" STS Turbine			375STS7D6B-0264	97060375102*	-	-				
20FDSP-10HP	90042084	F3, 10 hp, 380VAC, 60 Hz, 4"	581038501994-87IS004	20	4" Tri-Seal	20FA10S4-PE	93822045	-	-	10	380	4"	2345498602G
25FDSP-10HP	90042584			25	4" Tri-Seal	25FA10S4-PE	93822545	-	-				
35FDSP-10HP	90043584			35	4" High Cap	35FH10S4-PE	93653538*	35S4	0.83				
45FDSP-10HP	90044584			45	4" High Cap	45FH10S4-PE	93654531*	45S4	0.89				
60FDSP-10HP	90046084			60	4" High Cap	60FH10S4-PE	93656030*	60S4	0.94				
90FDSP-10HP	90049084			90	4" High Cap	90FH10S4-PE	93659025*	90S4	0.92				
100FDSP-10HP	90040184			100	6" High Cap	100FH10S6-PE	93650006*	100S6	N/A				
125FDSP-10HP	90041284			125	6" High Cap	125FH10S6-PE	93652505*	125S6	N/A				
150FDSP-10HP	90040284			150	5" STS Turbine	150STS10D5A-0443	97050150004*	-	-				
180FDSP-10HP	90041884			180	5" STS Turbine	180STS10D5A-0544	97050180005*	-	-				
220FDSP-10HP	90042284			220	5" STS Turbine	220STS10D5X-0544	97050220005*	-	-				
275FDSP-10HP	90042784			F3, 10 hp, 380VAC, 60 Hz, 6"	581038501994-SPIS005	275	6" STS Turbine	275STS10D6X-0364	97060275303*				
325FSP-10HP	90043284	325	6" STS Turbine			325STS10D6B-0364	97060325103*	-	-				
375FDSP-10HP	90043784	375	6" STS Turbine			375STS10D6A-0264	97060375002*	-	-				

\* Indicates pumps w/o built-in check valve. Output flow may vary due to additional head requirements from check-valve

Included Flow Switch (NPT)	
Model	Part No.
F21	226019102

NOTE: 30 ft. (10 meter) cable for use with the flow switch is included in the controller packaging

# PHOTON™ SOLARPAK - 5.0 HP (3.7 KW) PERFORMANCE

## 10FDSP-5.0HP

Photon™ Solar 5.0 hp Controller, 10 US gpm 5.0 hp Pump End, 5.0 HP 230 V 3-phase Motor

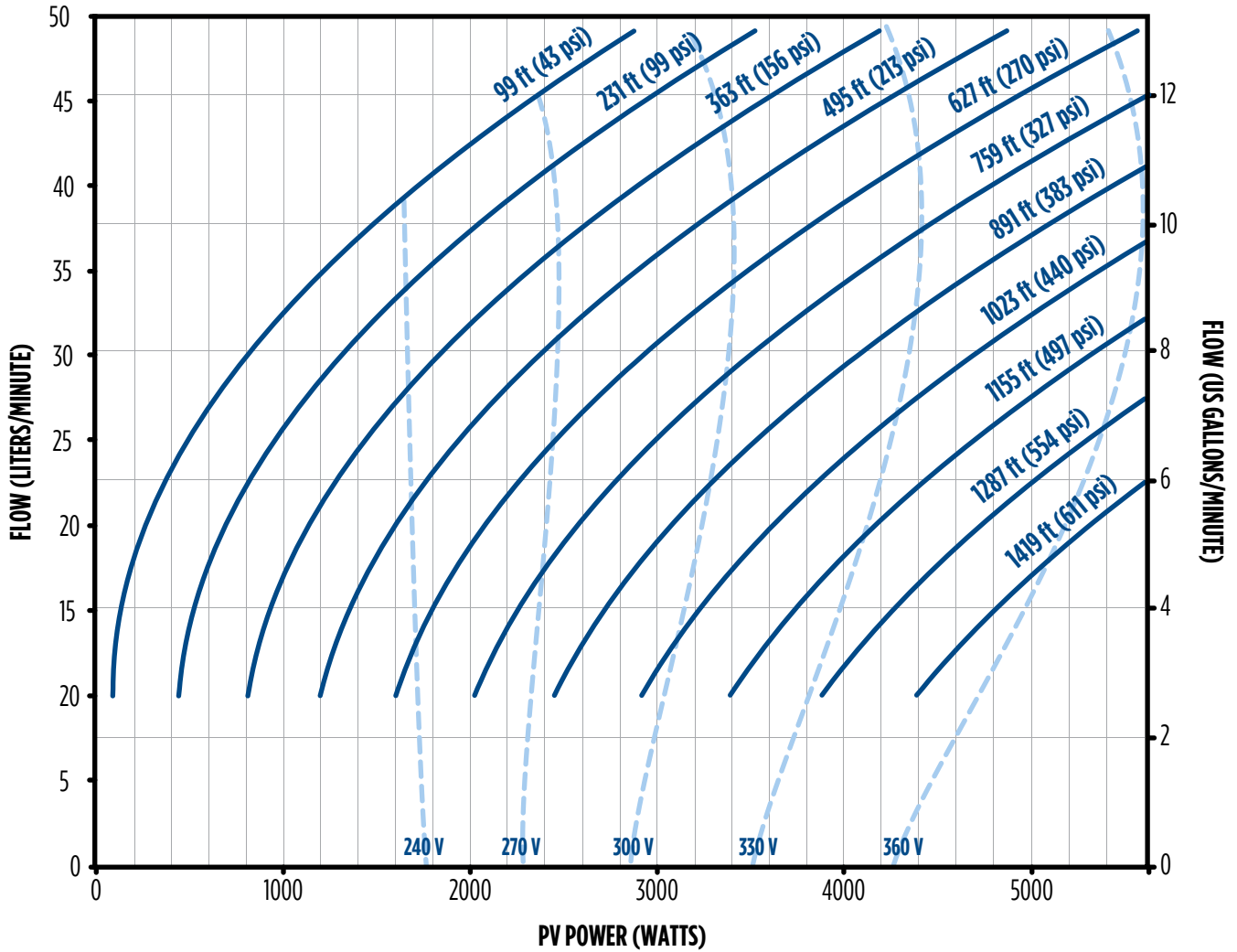



# PHOTON™ SOLARPAK - 5.0 HP (3.7 KW) PERFORMANCE

## 15FDSP-5.0HP

Photon™ Solar 5.0 hp Controller, 15 US gpm 5.0 hp Pump End, 5.0 hp 230 V 3-phase Motor

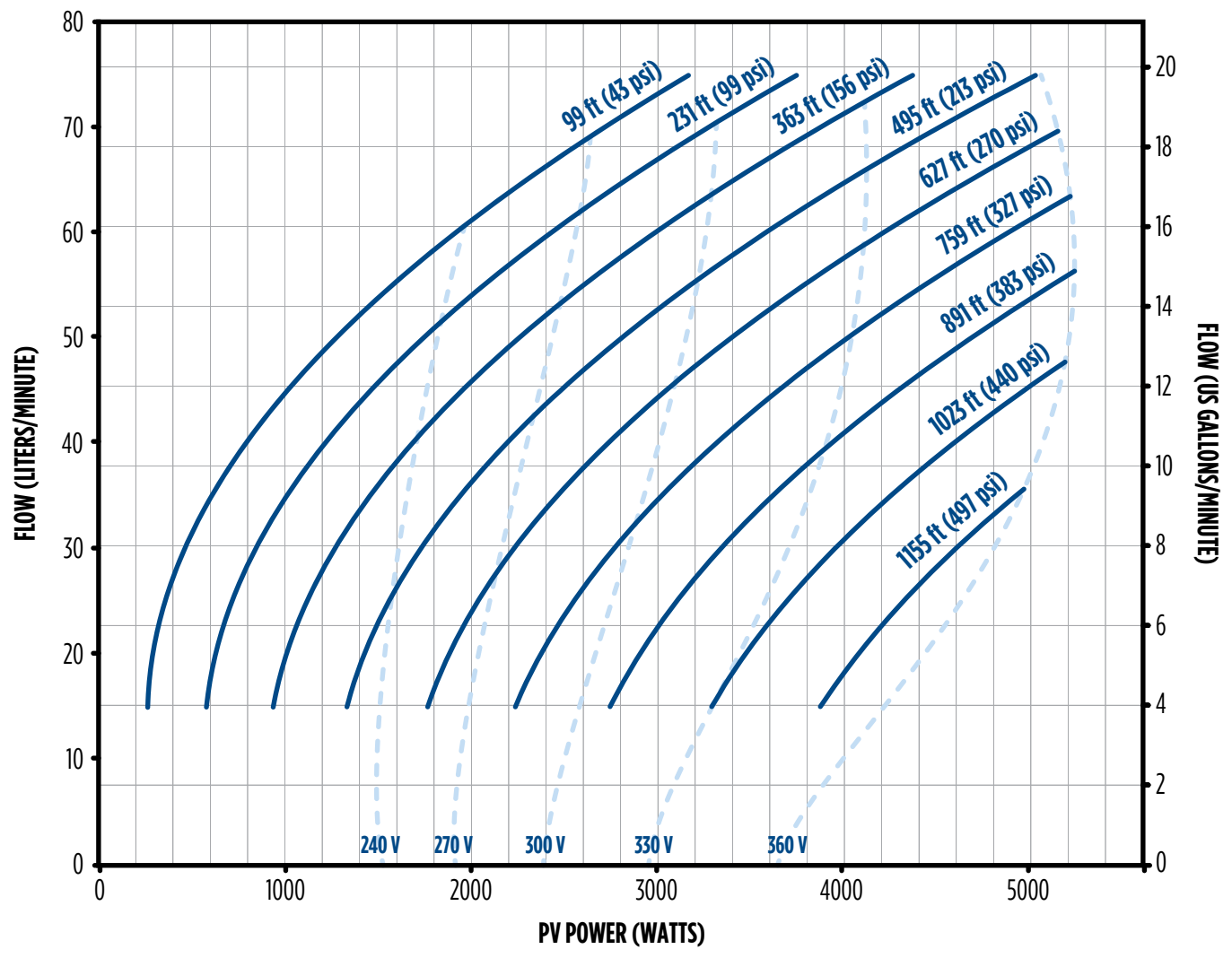



# PHOTON™ SOLARPAK - 5.0 HP (3.7 KW) PERFORMANCE

## 25FDSP-5.0HP

Photon™ Solar 5.0 hp Controller, 25 US gpm 5.0 hp Pump End, 5.0 hp 230 V 3-phase Motor

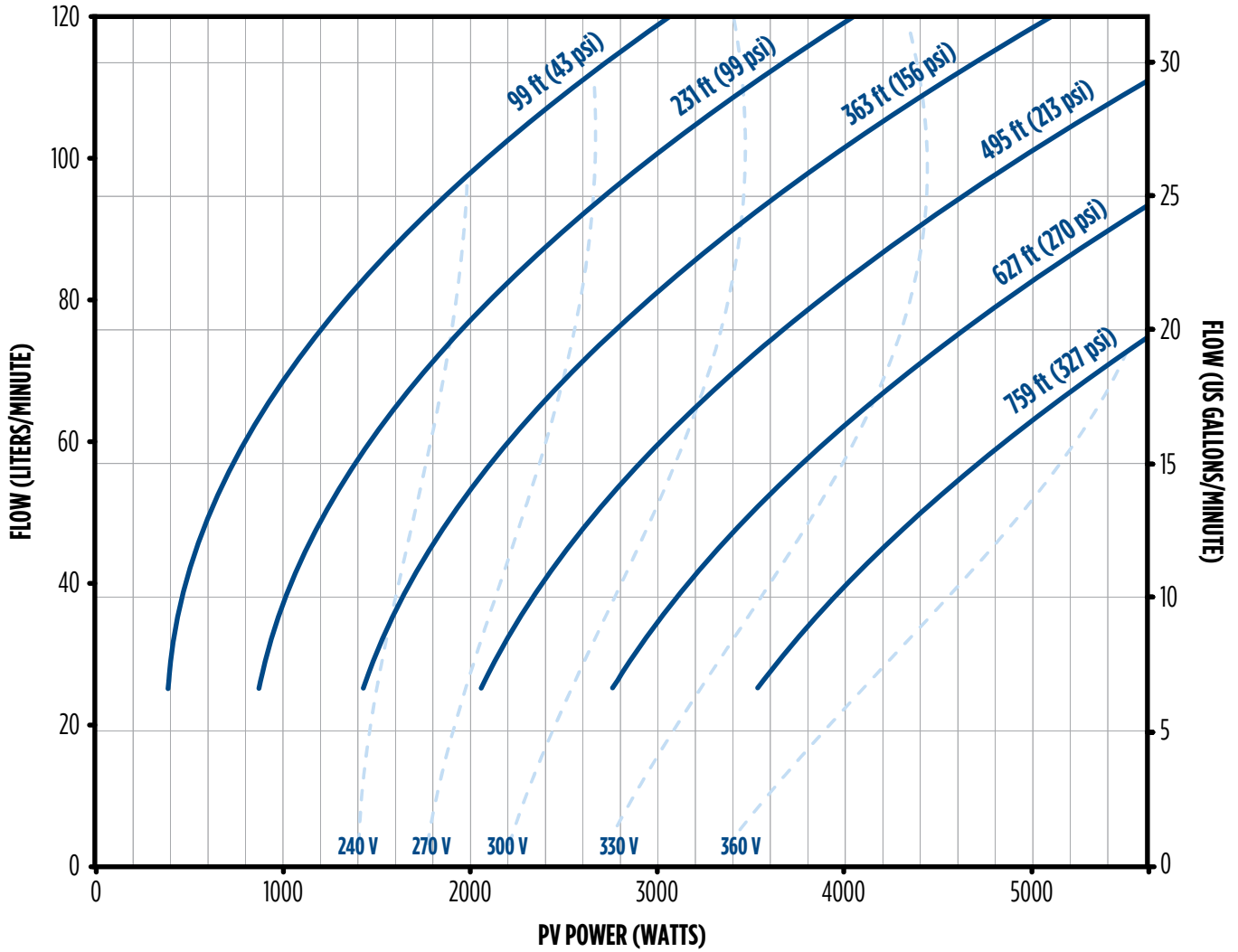

# PHOTON™ SOLARPAK - 5.0 HP (3.7 KW) PERFORMANCE

35FDSP-5.0HP

Photon™ Solar 5.0 hp Controller, 35 US gpm 5.0 hp Pump End, 5.0 hp 230 V 3-phase Motor

Basic Model	PEI <sub>CL</sub> Number
35S4	0.83

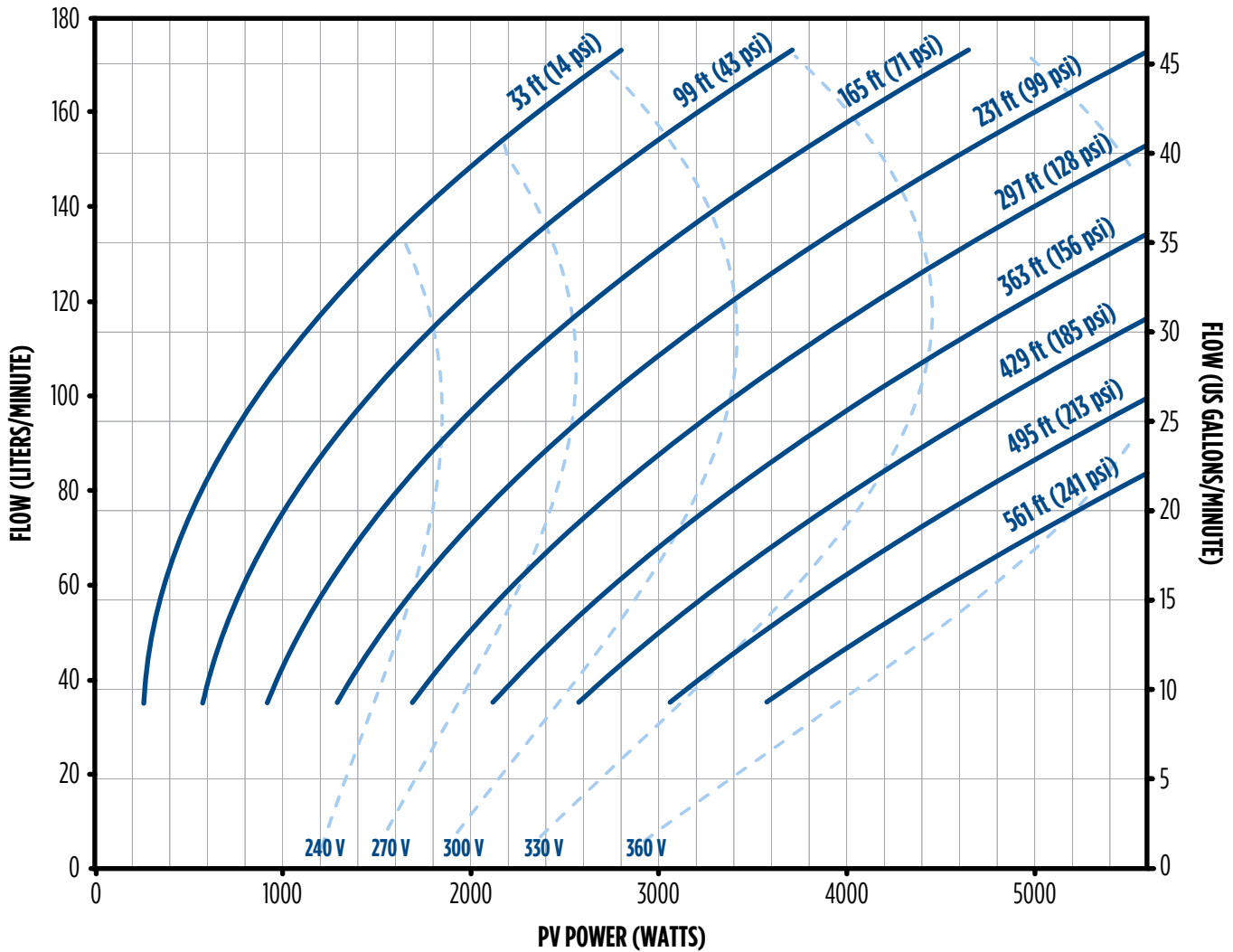

### PHOTON™ SOLARPAK - 5.0 HP (3.7 KW) PERFORMANCE

45FDSP-5.0HP

Photon™ Solar 5.0 hp Controller, 45 US gpm 5.0 hp Pump End, 5.0 hp 230 V 3-phase Motor

Basic Model	PEI <sub>CL</sub> Number
45S4	0.89

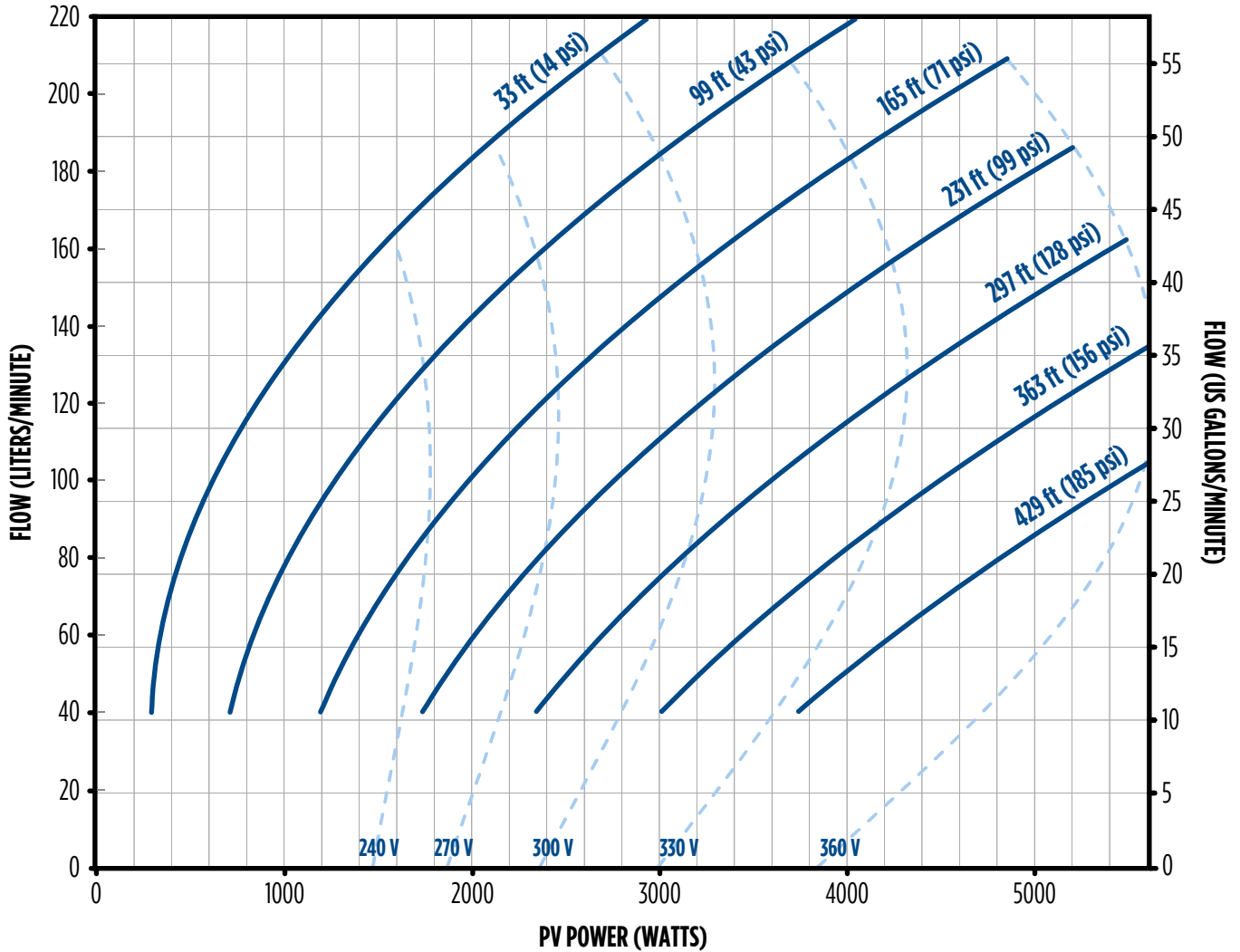

# PHOTON™ SOLARPAK - 5.0 HP (3.7 KW) PERFORMANCE

## 60FDSP-5.0HP

Photon™ Solar 5.0 hp Controller, 60 US gpm 5.0 hp Pump End, 5.0 hp 230 V 3-phase Motor

Basic Model	PEI <sub>c</sub> Number
60S4	0.94

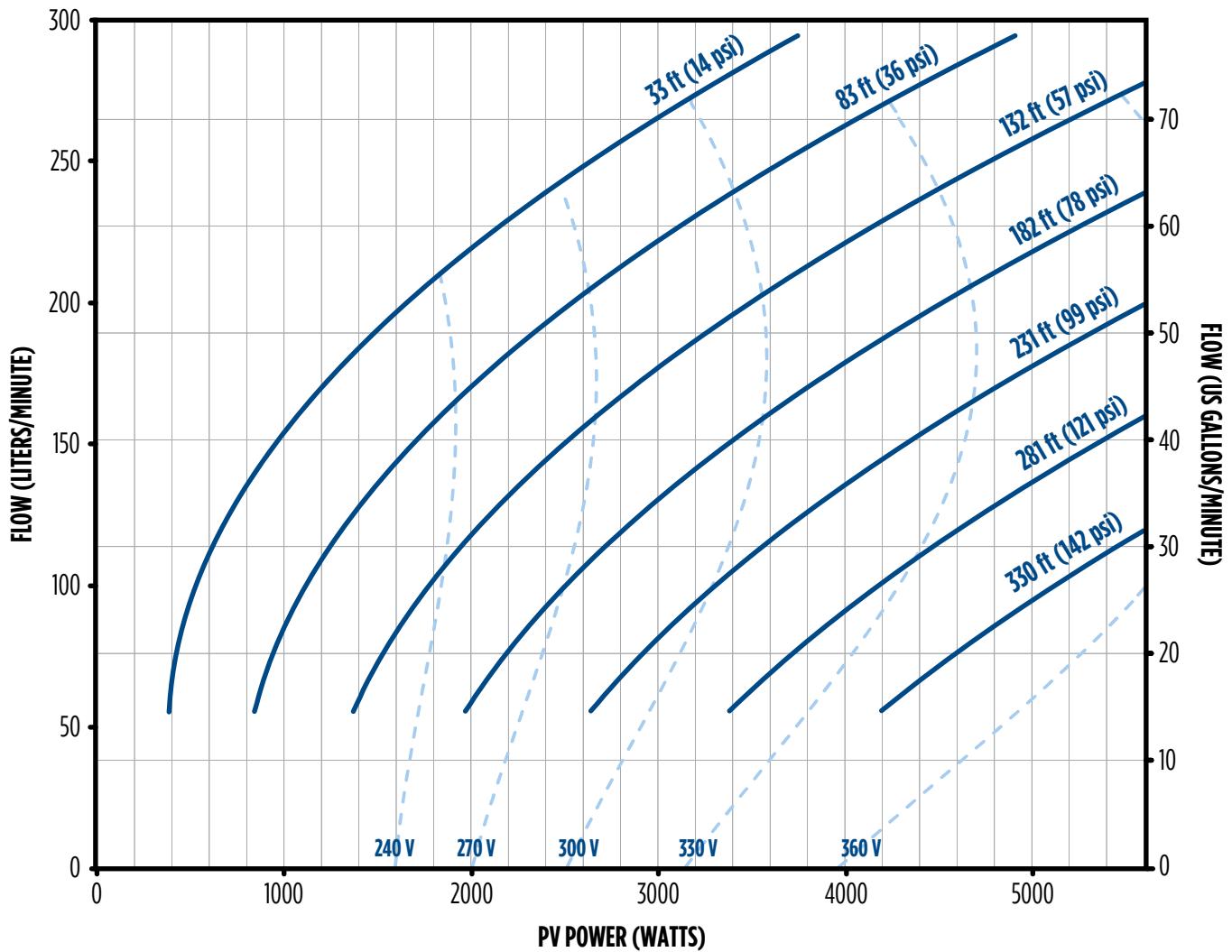

## PHOTON™ SOLARPAK - 5.0 HP (3.7 KW) PERFORMANCE

### 90FDSP-5.0HP

Photon™ Solar 5.0 hp Controller, 90 US gpm 5.0 hp Pump End, 5.0 hp 230 V 3-phase Motor

Basic Model	PEI <sub>c</sub> Number
90S4	0.92

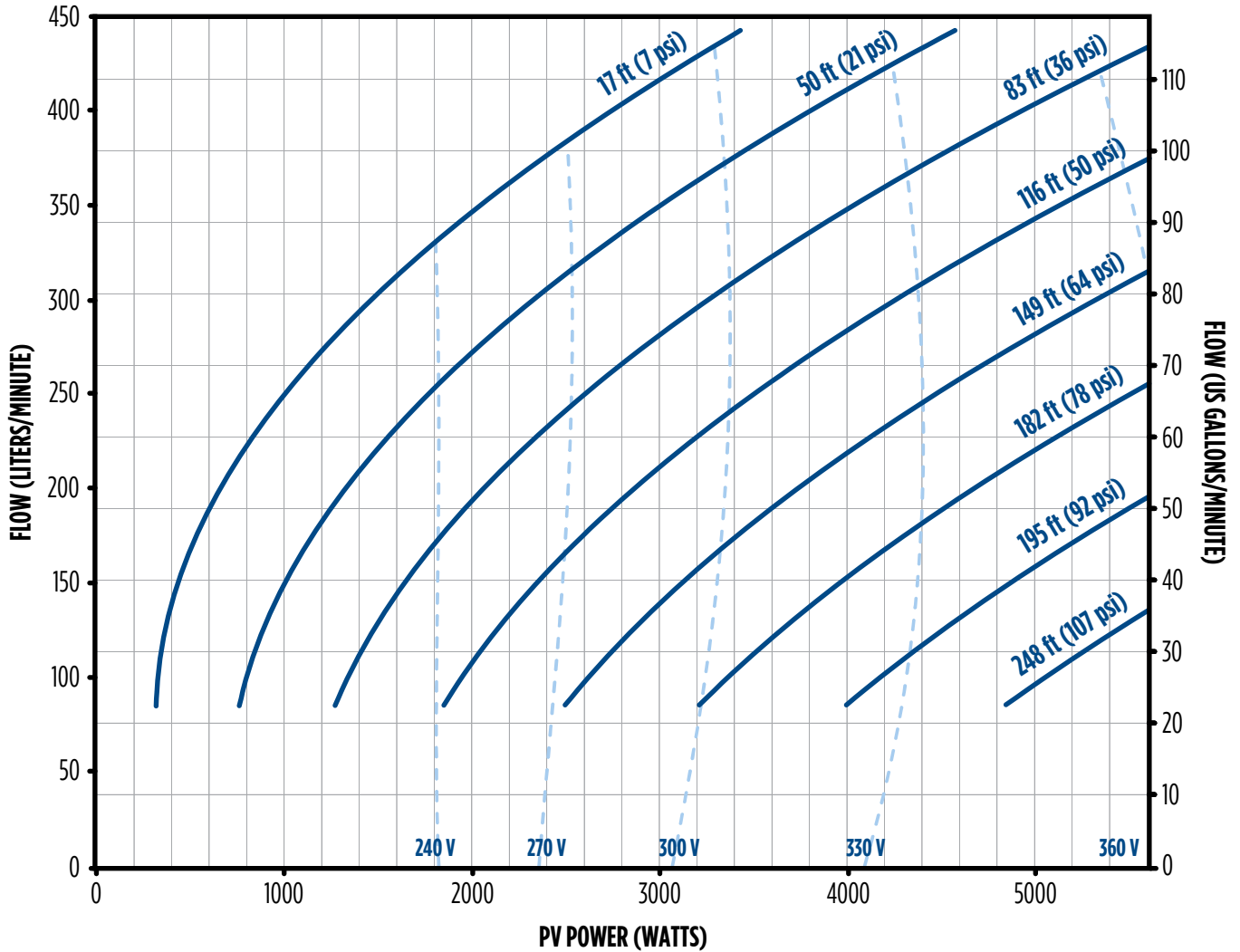

# PHOTON™ SOLARPAK - 5.0 HP (3.7 KW) PERFORMANCE

100FDSP-5.0HP

Photon™ Solar 5.0 hp Controller, 100 US gpm 5.0 hp Pump End, 5.0 hp 230 V 3-phase Motor

Basic Model	PEI <sub>c</sub> Number
100S4	N/A

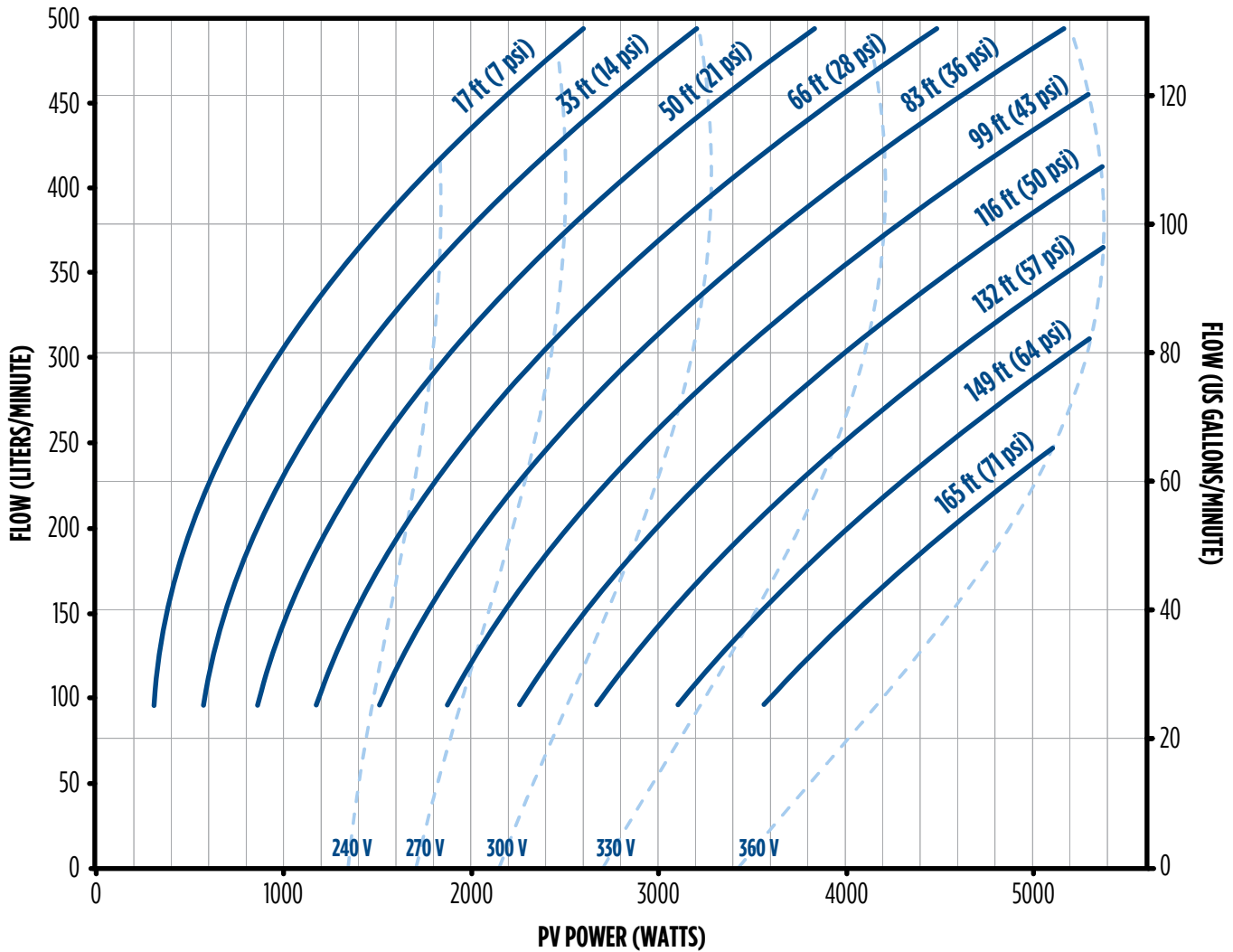

### PHOTON™ SOLARPAK - 5.0 HP (3.7 KW) PERFORMANCE

#### 125FDSP-5.0HP

Photon™ Solar 5.0 hp Controller, 125 US gpm 5.0 hp Pump End, 5.0 hp 230 V 3-phase Motor

Basic Model	PEI <sub>c</sub> Number
125S4	N/A

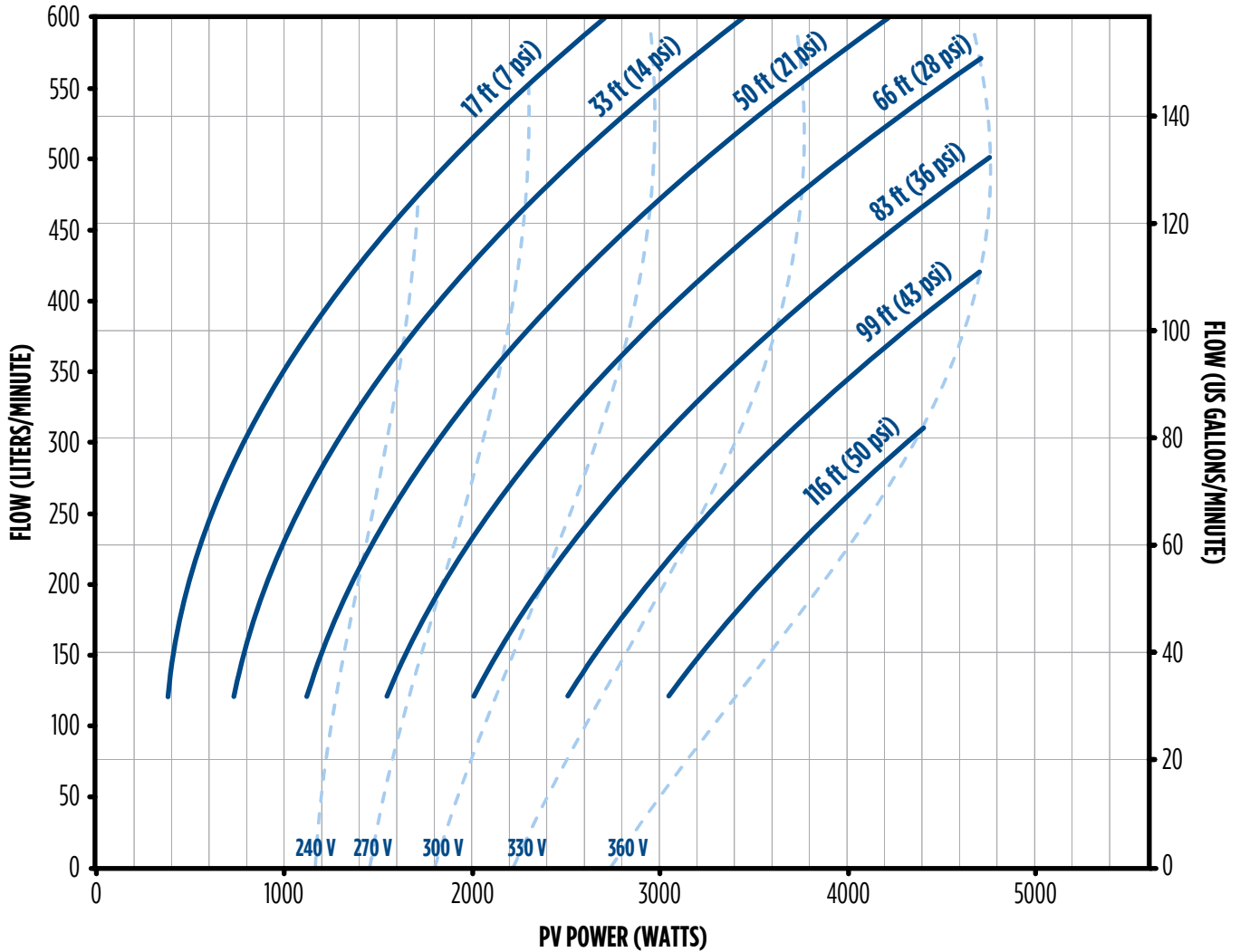

# PHOTON™ SOLARPAK - 5.0 HP (3.7 KW) PERFORMANCE

## 150FDSP-5.0HP

Photon™ Solar 5.0 hp Controller, 150 US gpm 5.0 hp Pump End, 5.0 hp 230 V 3-phase Motor

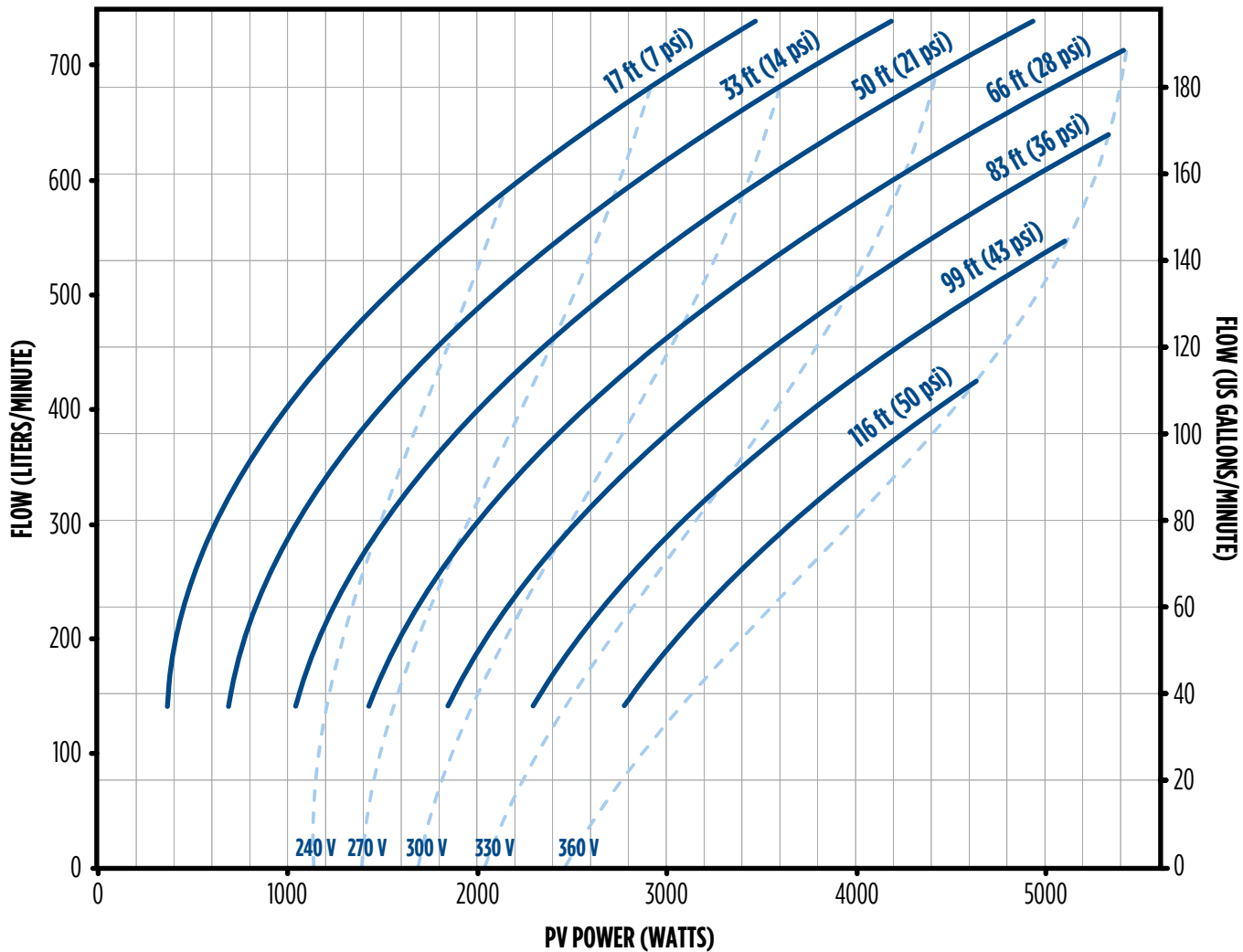



## PHOTON™ SOLARPAK - 5.0 HP (3.7 KW) PERFORMANCE

### 180FDSP-5.0HP

Photon™ Solar 5.0 hp Controller, 180 US gpm 5.0 hp Pump End, 5.0 hp 230 V 3-phase Motor

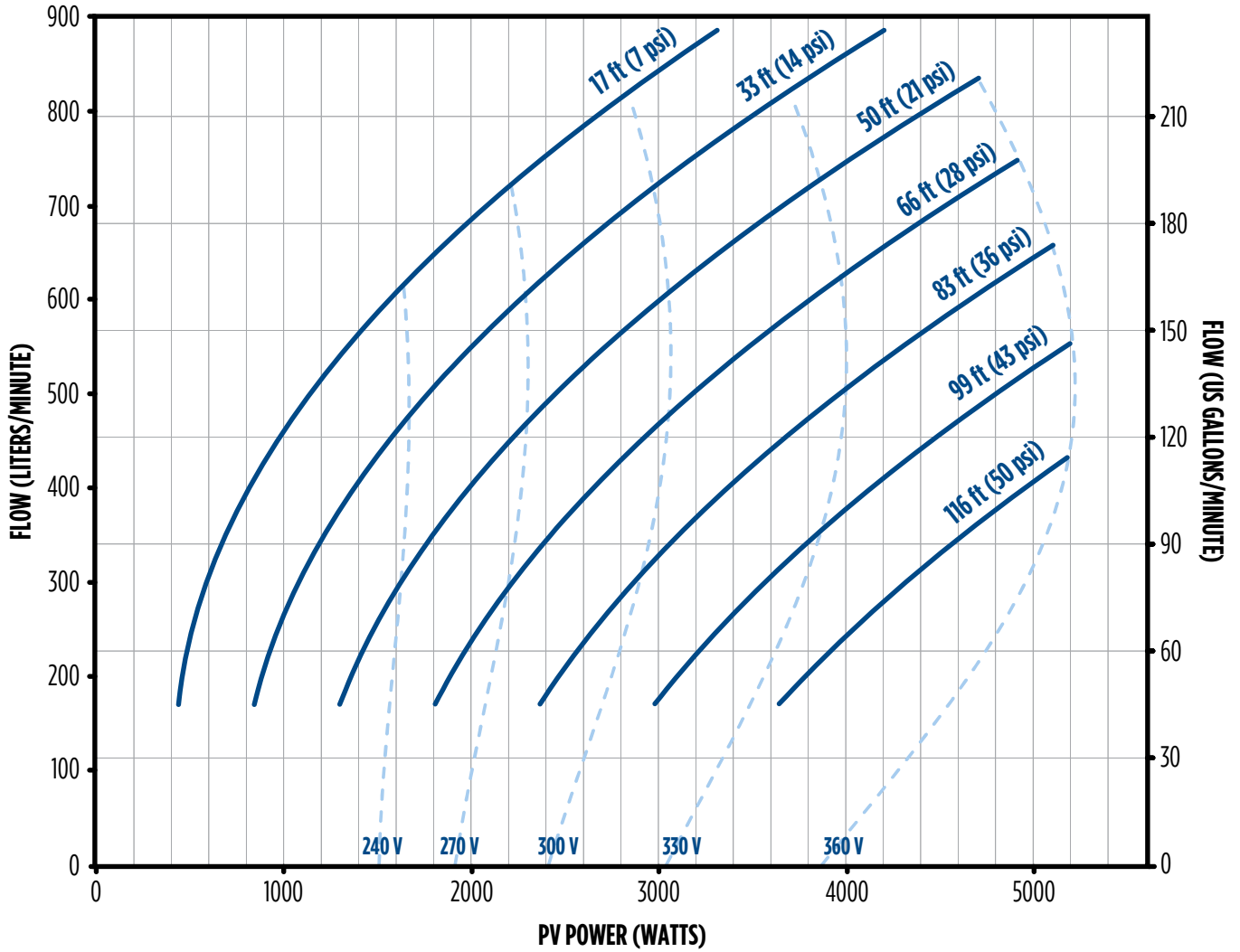

# PHOTON™ SOLARPAK - 5.0 HP (3.7 KW) PERFORMANCE

## 220FDSP-5.0HP

Photon™ Solar 5.0 hp Controller, 220 US gpm 5.0 hp Pump End, 5.0 hp 230 V 3-phase Motor

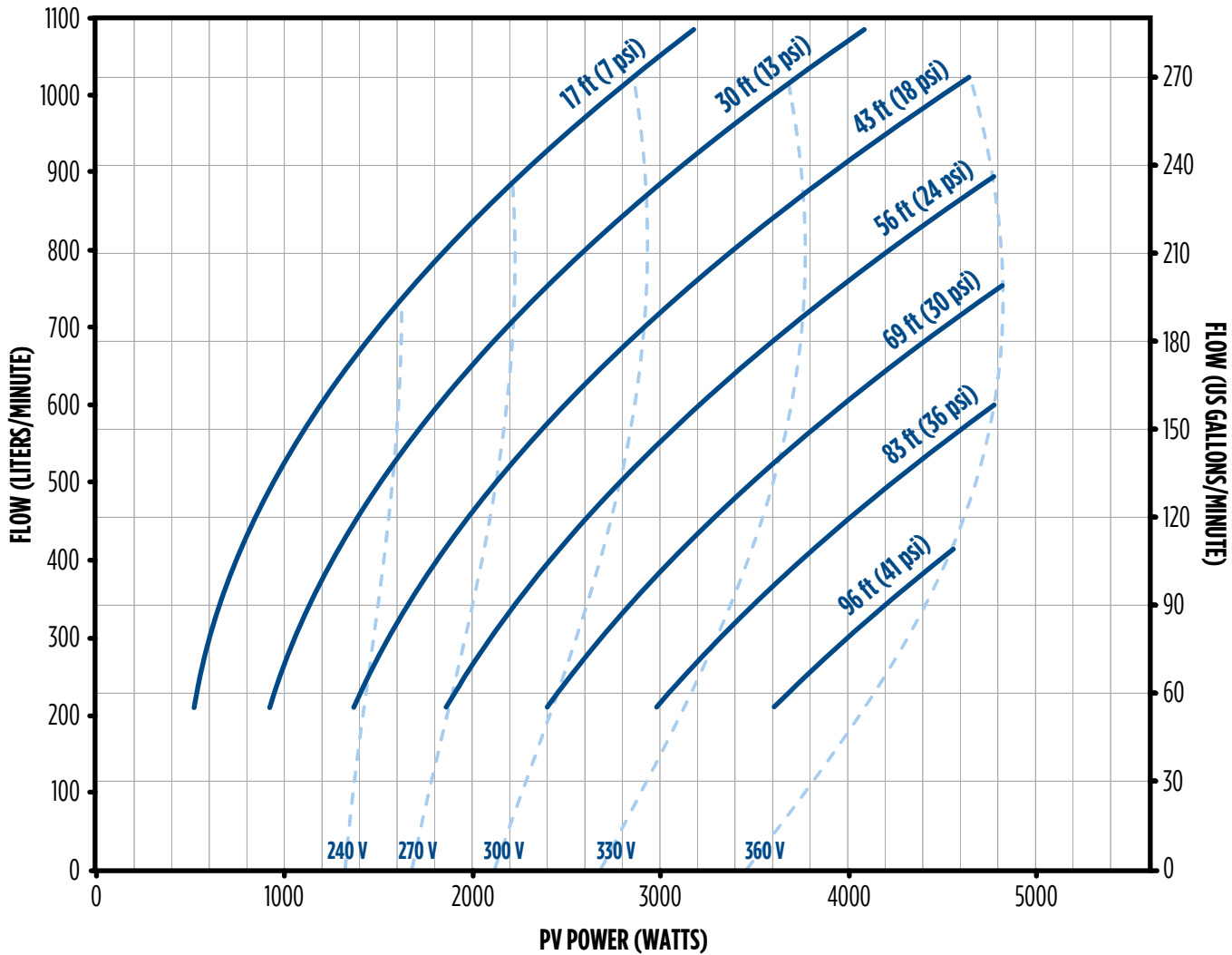

## PHOTON™ SOLARPAK - 5.0 HP (3.7 KW) PERFORMANCE

### 275FDSP-5.0HP

Photon™ Solar 5.0 hp Controller, 275 US gpm 5.0 hp Pump End, 5.0 hp 230 V 3-phase Motor

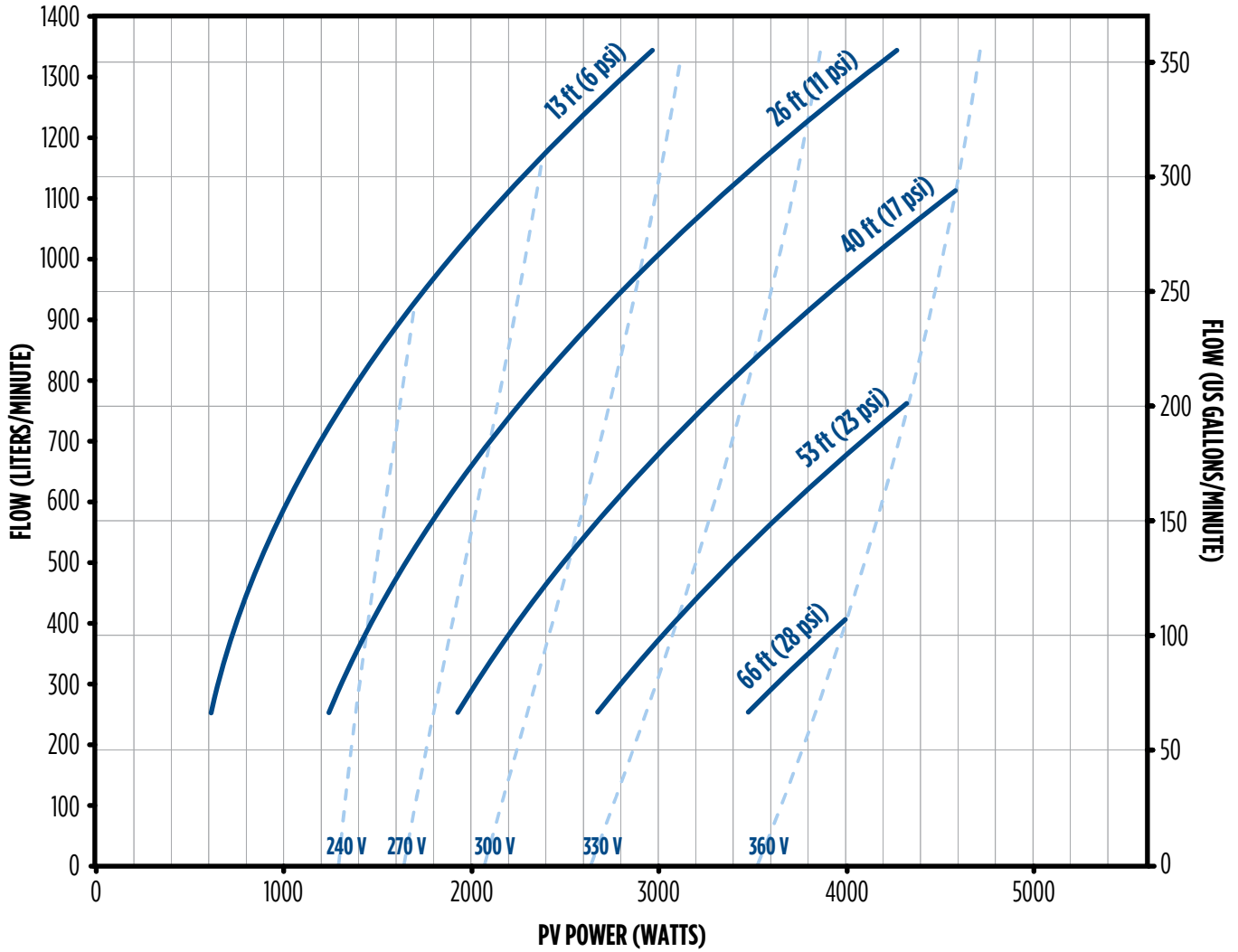

## PHOTON™ SOLARPAK - 5.0 HP (3.7 KW) PERFORMANCE

### 325FDSP-5.0HP

Photon™ Solar 5.0 hp Controller, 325 US gpm 5.0 hp Pump End, 5.0 hp 230 V 3-phase Motor

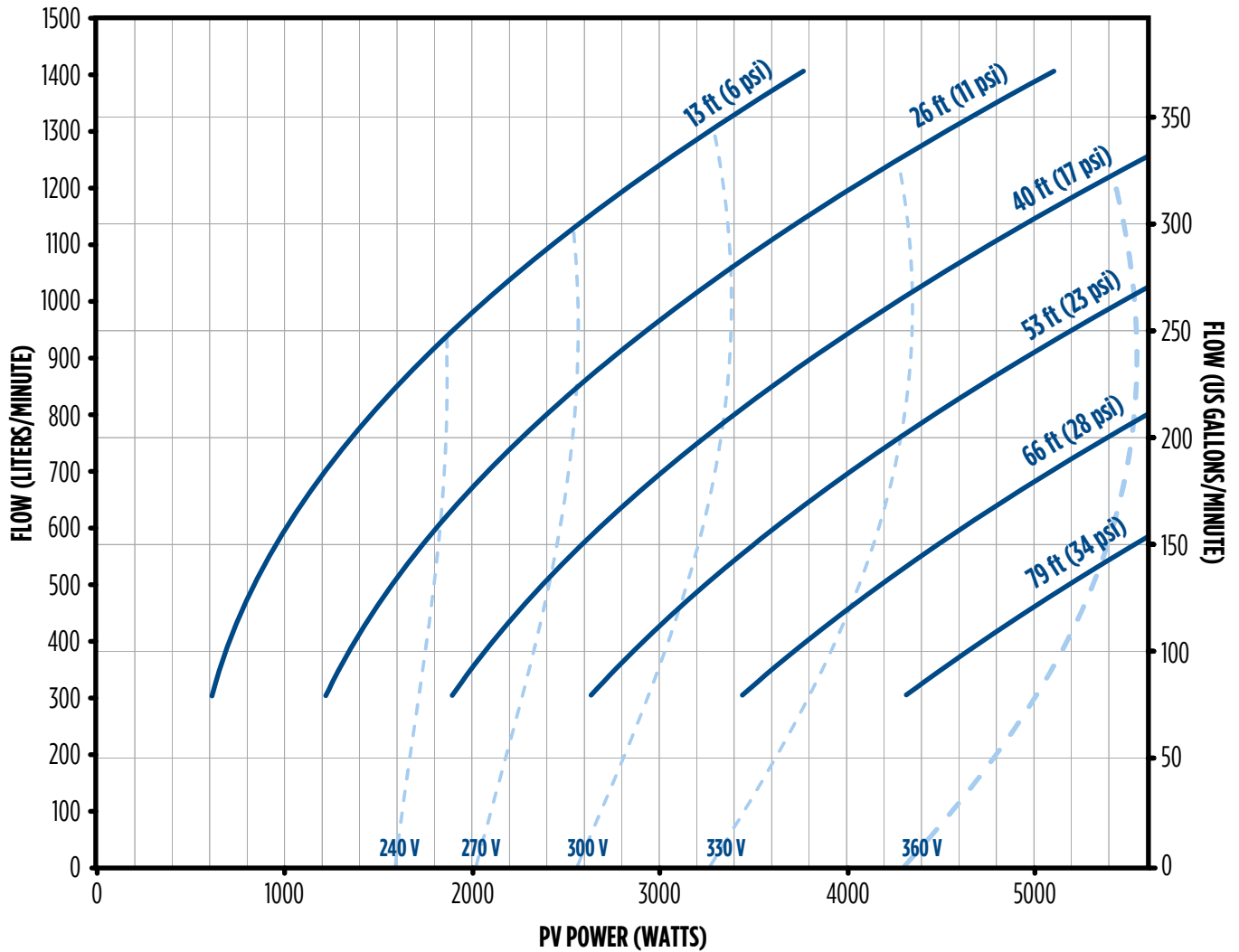

## PHOTON™ SOLARPAK - 5.0 HP (3.7 KW) PERFORMANCE

### 375FDSP-5.0HP

Photon™ Solar 5.0 hp Controller, 375 US gpm 5.0 hp Pump End, 5.0 hp 230 V 3-phase Motor

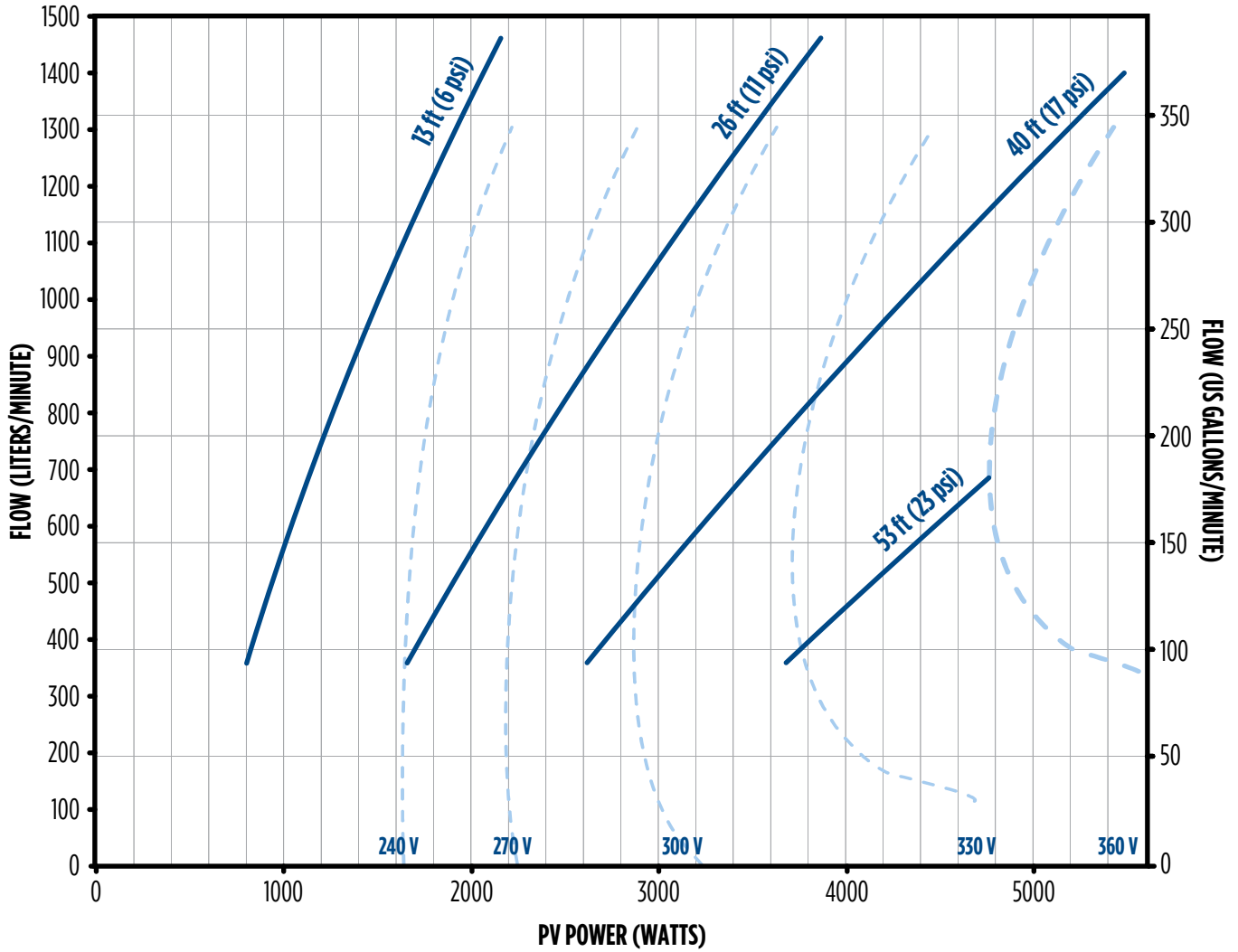

# PHOTON™ SOLARPAK - 7.5 HP (5.5 KW) PERFORMANCE

## 20FDSP-7.5HP

Photon™ Solar 7.5 hp Controller, 20 US gpm 5.0 hp Pump End, 7.5 hp 380 V 3-phase Motor

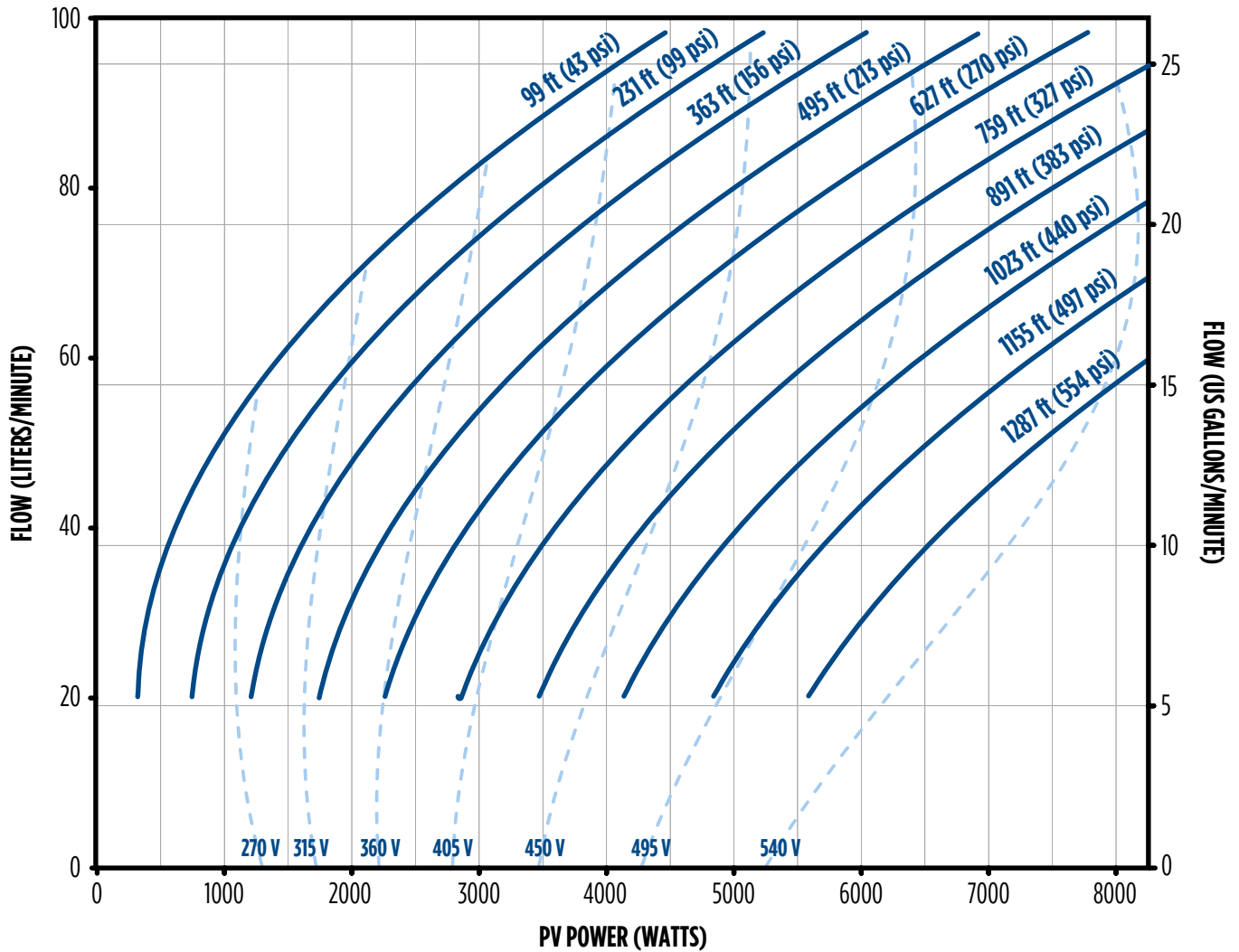

# PHOTON™ SOLARPAK - 7.5 HP (5.5 KW) PERFORMANCE

## 25FDSP-7.5HP

Photon™ Solar 7.5 hp Controller, 25 US gpm 5.0 hp Pump End, 7.5 hp 380 V 3-phase Motor

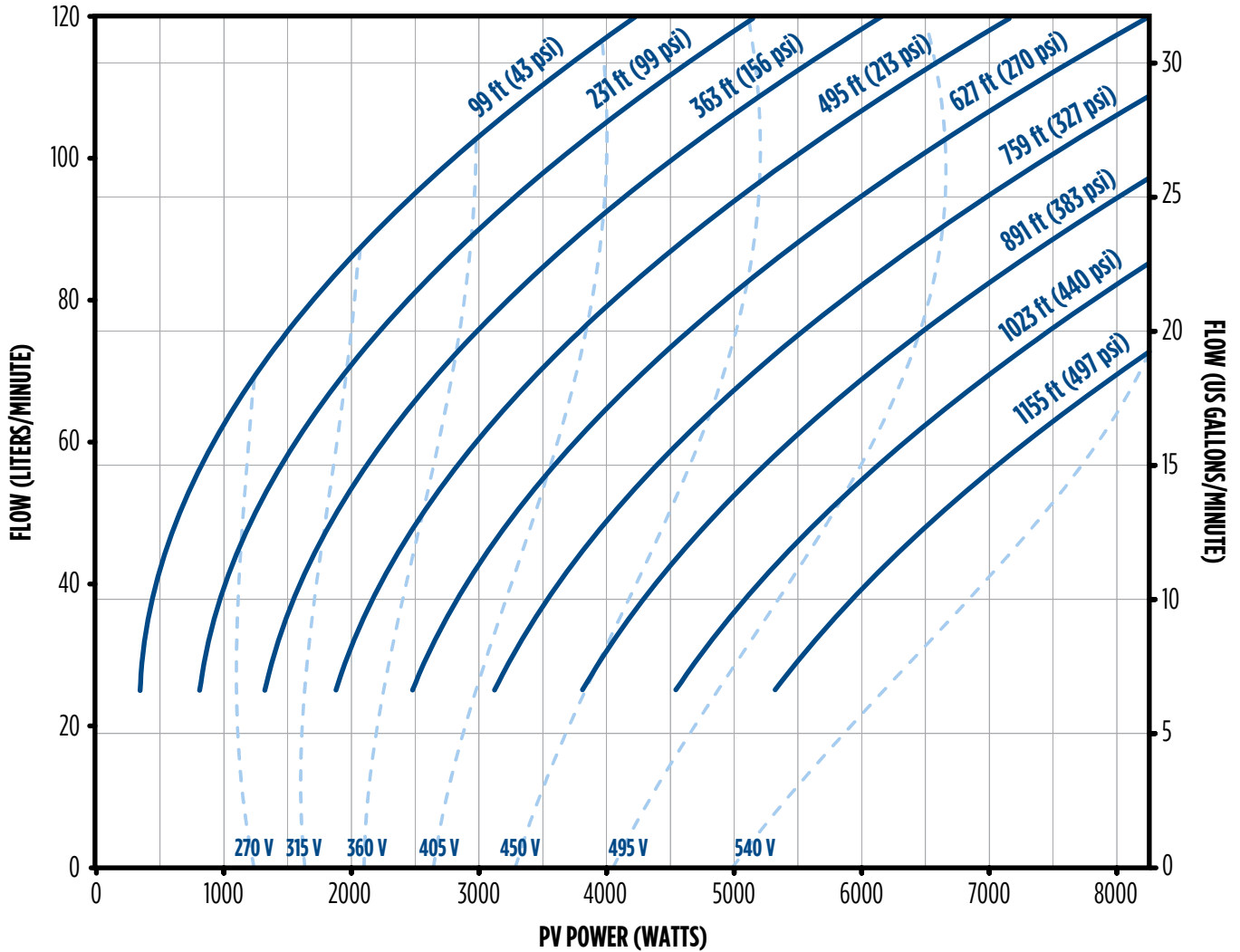

# PHOTON™ SOLARPAK - 7.5 HP (5.5 KW) PERFORMANCE

35FDSP-7.5HP

Photon™ Solar 7.5 hp Controller, 35 US gpm 5.0 hp Pump End, 7.5 hp 380 V 3-phase Motor

Basic Model	PEI <sub>c</sub> Number
35S4	0.83

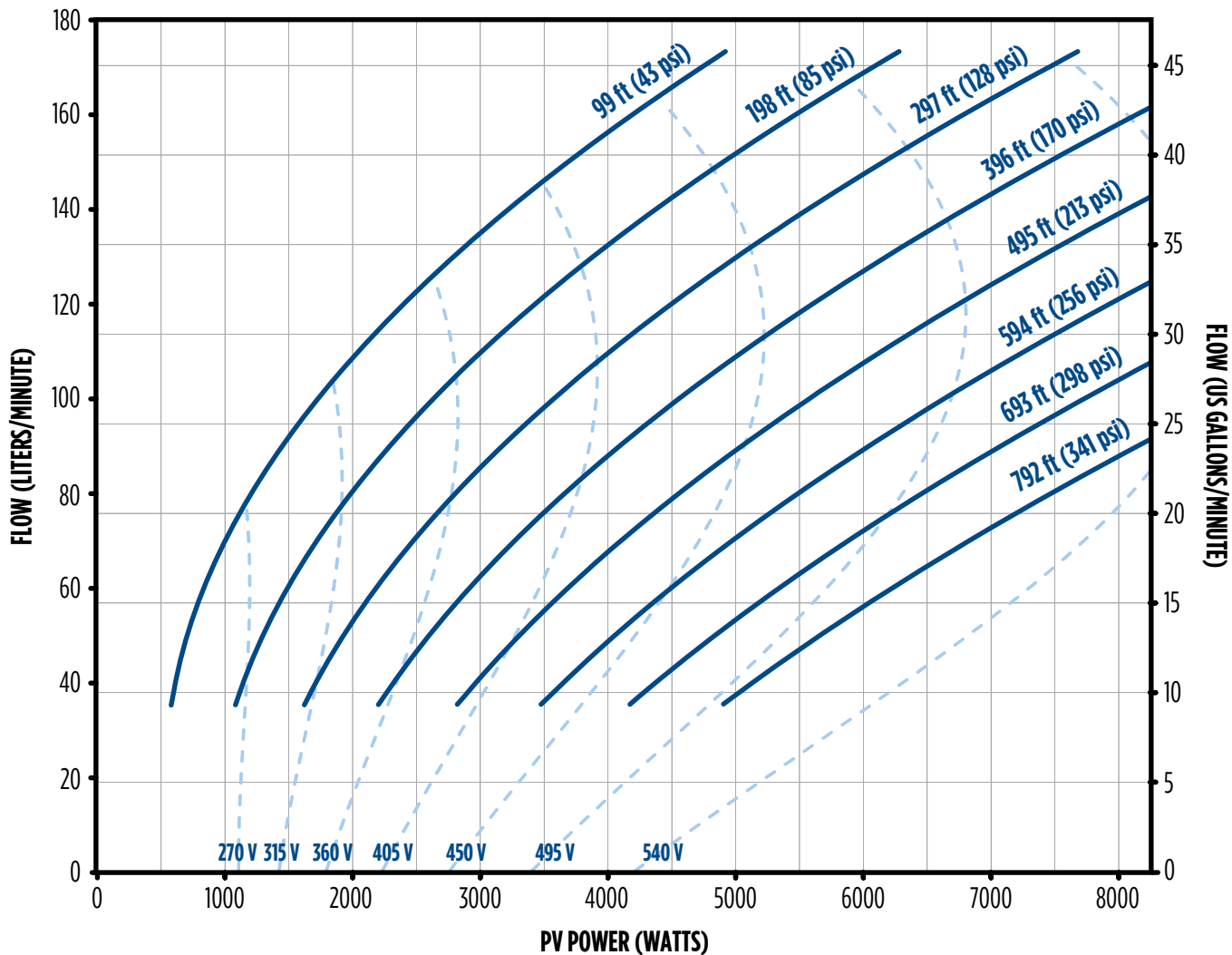



### PHOTON™ SOLARPAK - 7.5 HP (5.5 KW) PERFORMANCE

#### 45FDSP-7.5HP

Photon™ Solar 7.5 hp Controller, 45 US gpm 5.0 hp Pump End, 7.5 hp 380 V 3-phase Motor

Basic Model	PEL <sub>c</sub> Number
45S4	0.89

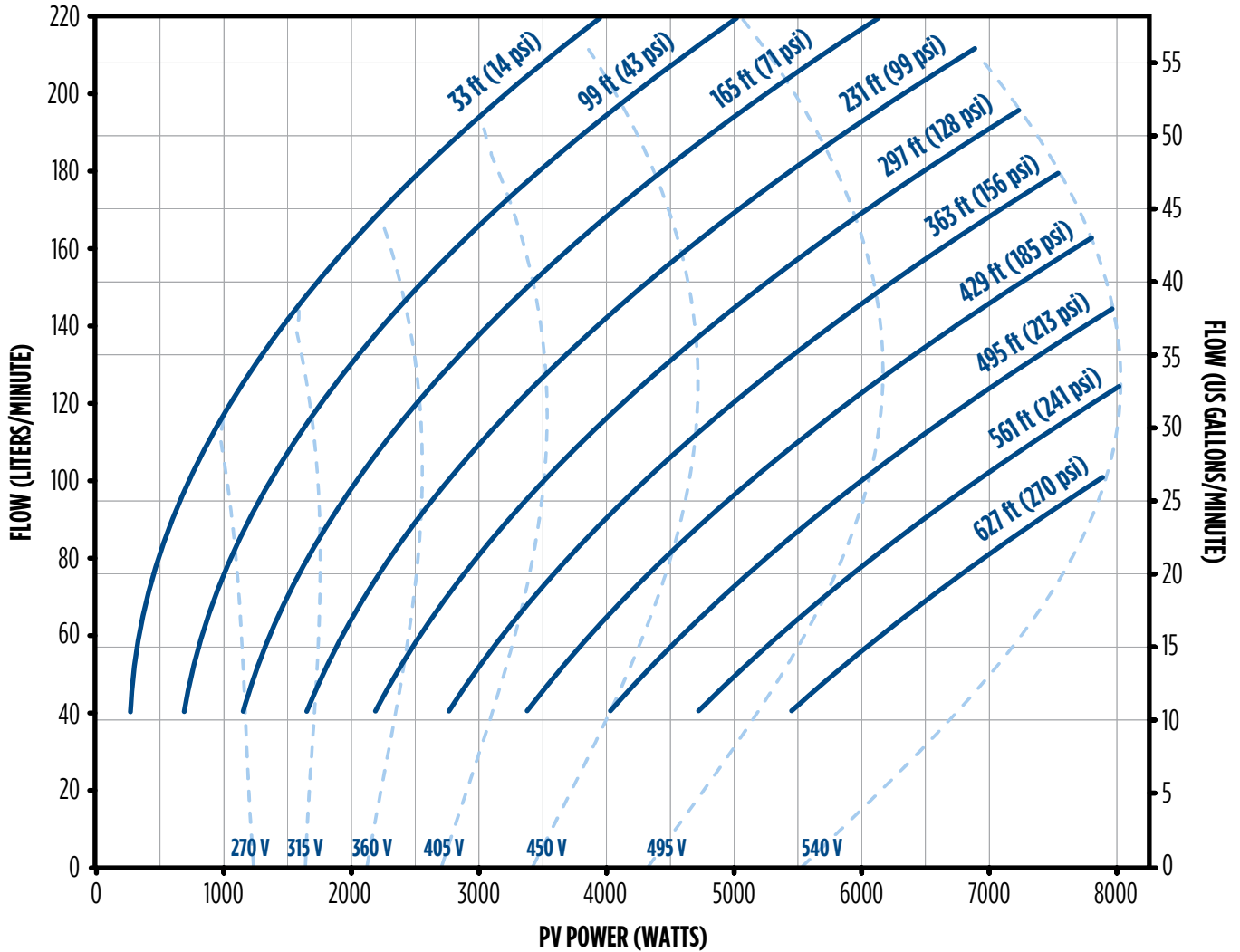

# PHOTON™ SOLARPAK - 7.5 HP (5.5 KW) PERFORMANCE

60FDSP-7.5HP

Photon™ Solar 7.5 hp Controller, 60 US gpm 5.0 hp Pump End, 7.5 hp 380 V 3-phase Motor

Basic Model	PEI <sub>CL</sub> Number
60S4	0.94

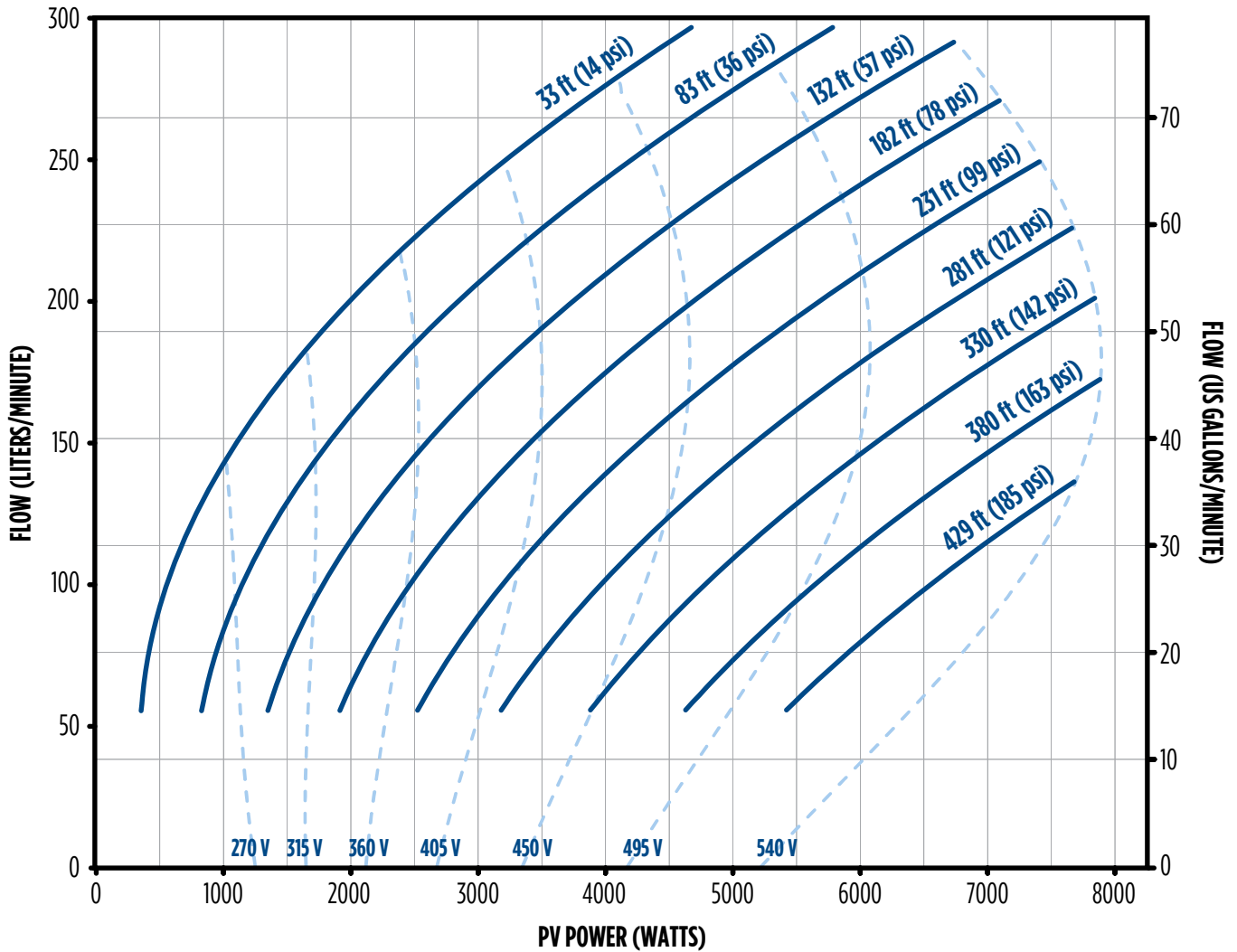

## PHOTON™ SOLARPAK - 7.5 HP (5.5 KW) PERFORMANCE

90FDSP-7.5HP

Photon™ Solar 7.5 hp controller, 90 US gpm 5.0 hp Pump End, 7.5 hp 380 V 3-phase Motor

Basic Model	PEI <sub>c</sub> Number
90S4	0.92

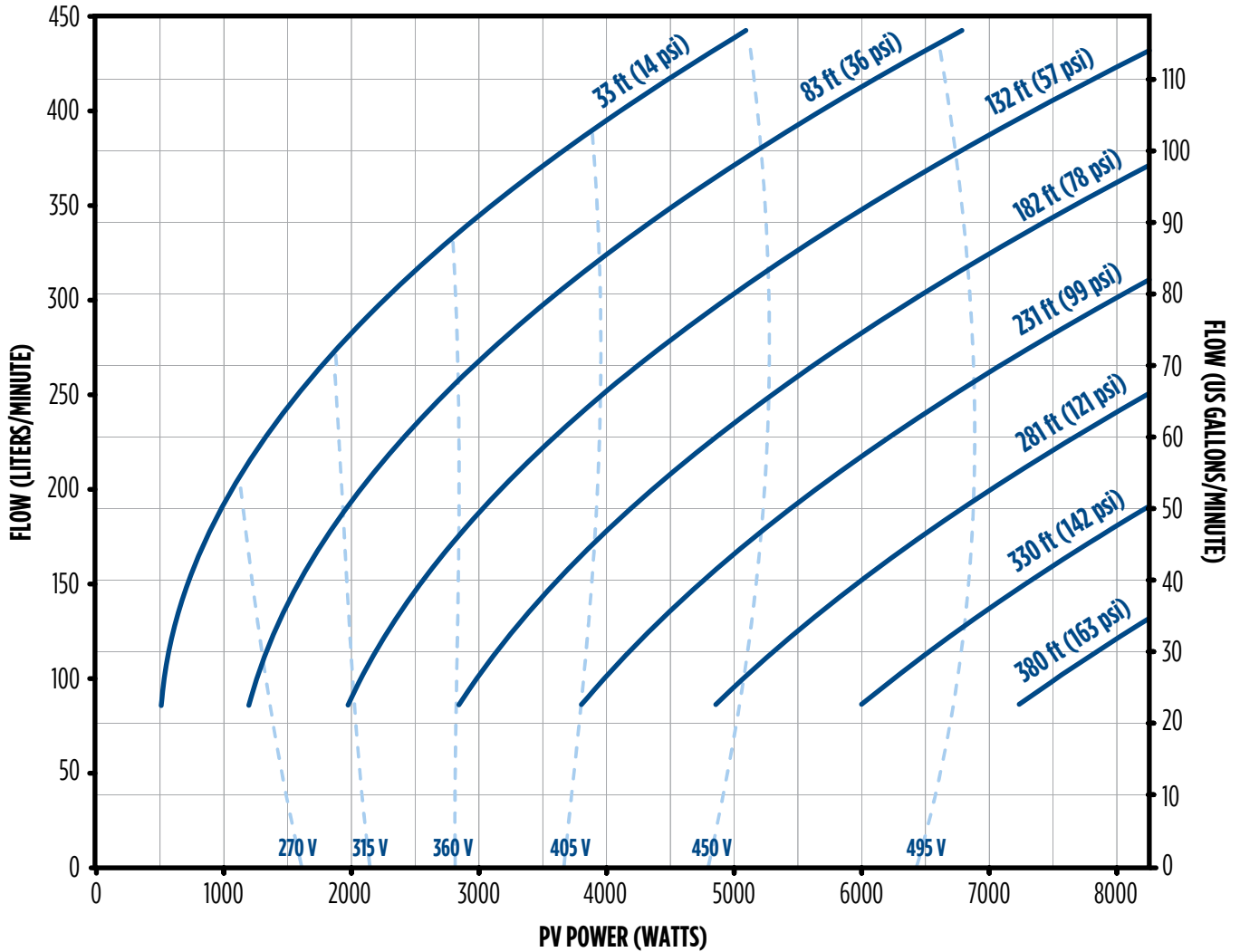

# PHOTON™ SOLARPAK - 7.5 HP (5.5 KW) PERFORMANCE

## 100FDSP-7.5HP

Photon™ Solar 7.5 hp Controller, 100 US gpm 5.0 hp Pump End, 7.5 hp 380 V 3-phase Motor

Basic Model	PEI <sub>c</sub> Number
100S4	N/A

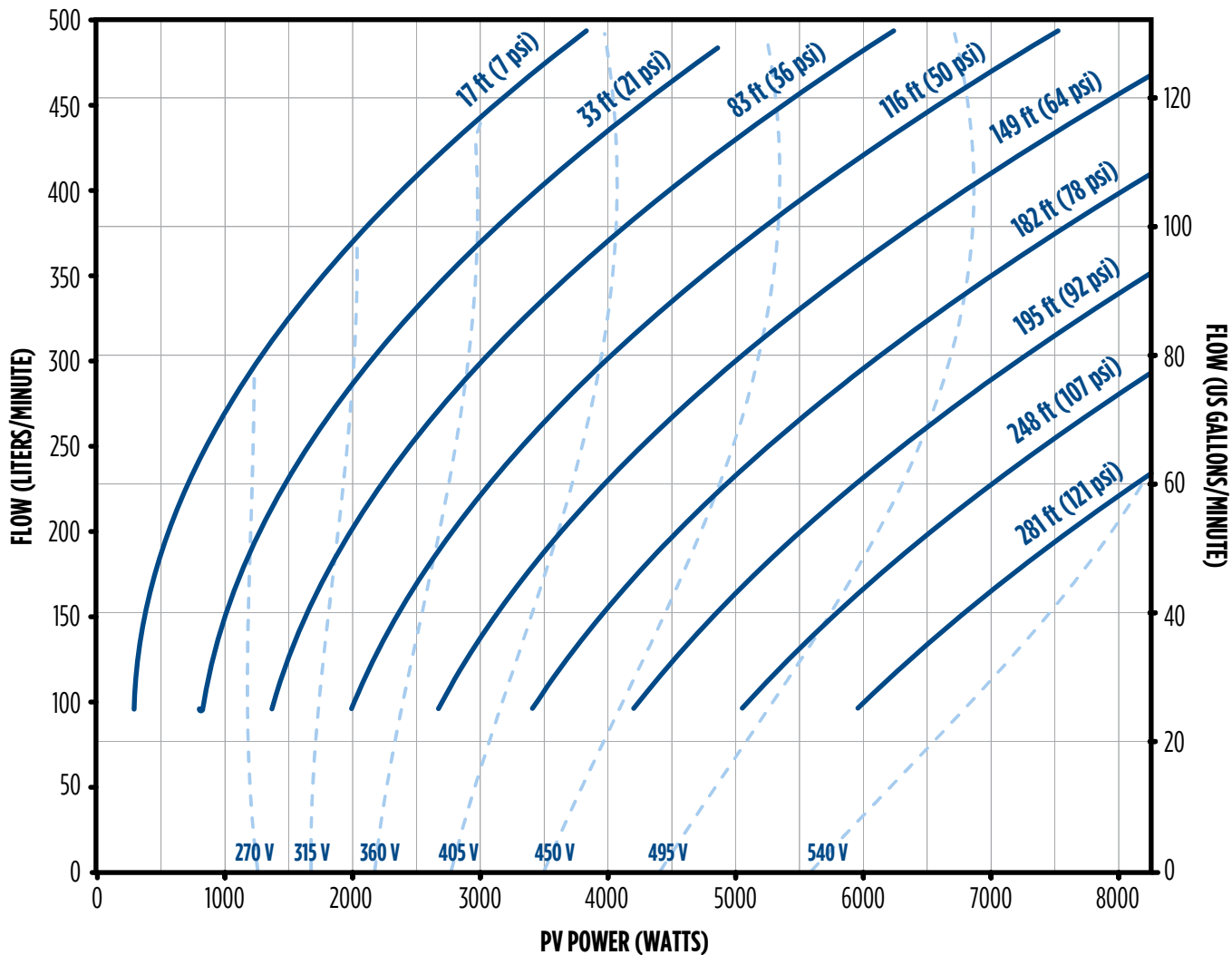

### PHOTON™ SOLARPAK - 7.5 HP (5.5 KW) PERFORMANCE

#### 125FDSP-7.5HP

Photon™ Solar 7.5 hp Controller, 125 US gpm 5.0 hp Pump End, 7.5 hp 380 V 3-phase Motor

Basic Model	PEI <sub>CL</sub> Number
125S4	N/A

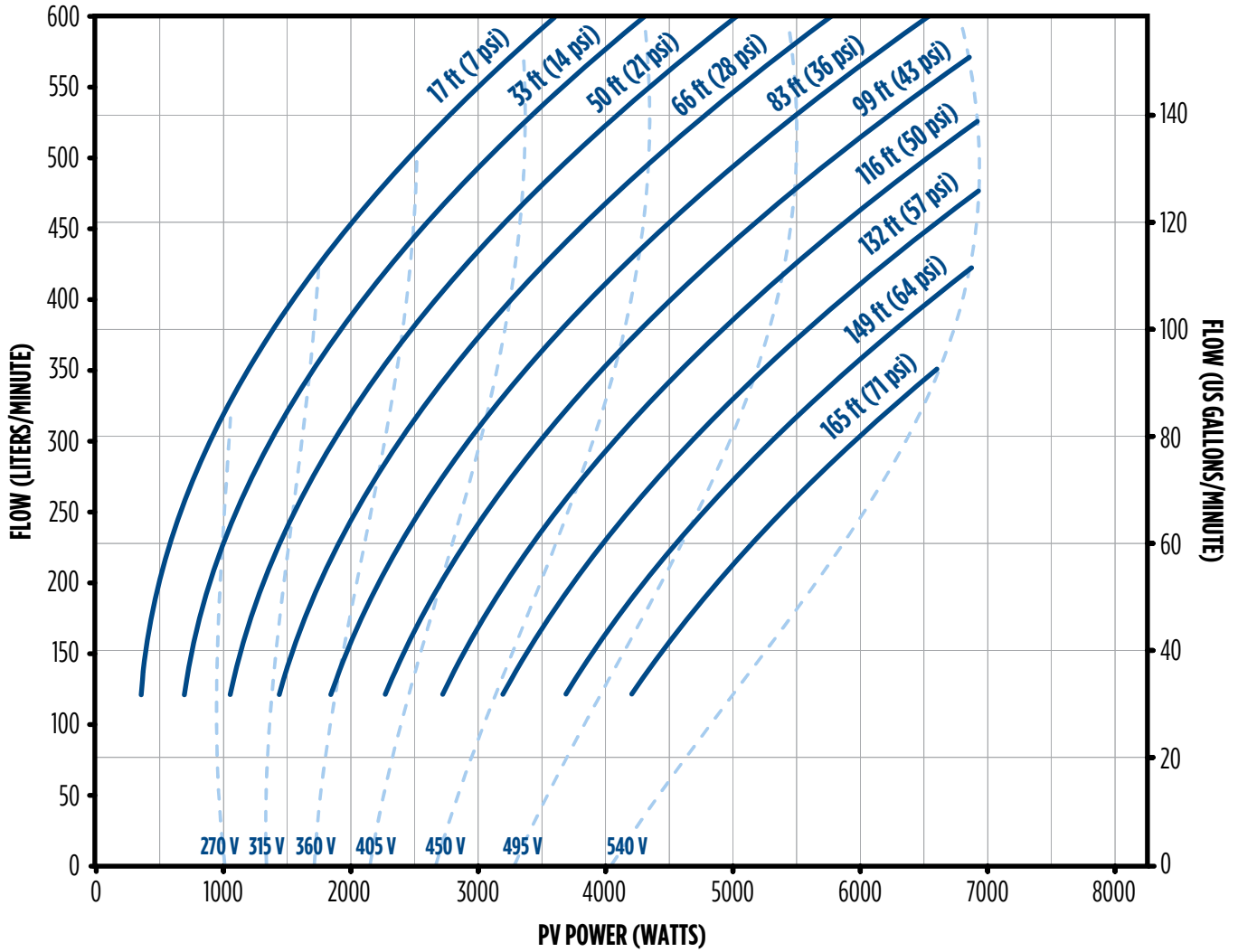

# PHOTON™ SOLARPAK - 7.5 HP (5.5 KW) PERFORMANCE

## 150FDSP-7.5HP

Photon™ Solar 7.5 hp Controller, 150 US gpm 5.0 hp Pump End, 7.5 hp 380 V 3-phase Motor

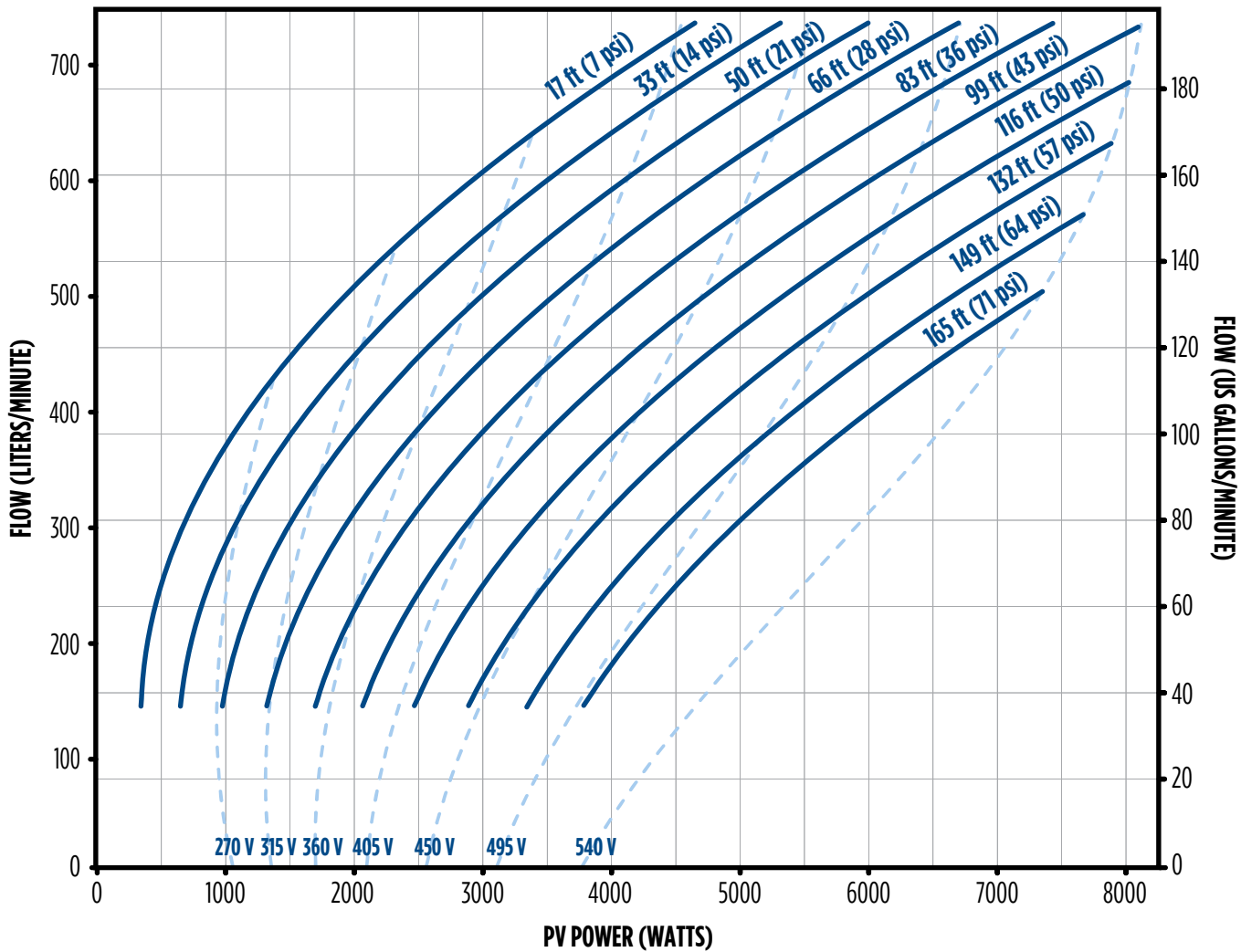

# PHOTON™ SOLARPAK - 7.5 HP (5.5 KW) PERFORMANCE

## 180FDSP-7.5HP

Photon™ Solar 7.5 hp Controller, 180 US gpm 5.0 hp Pump End, 7.5 hp 380 V 3-phase Motor

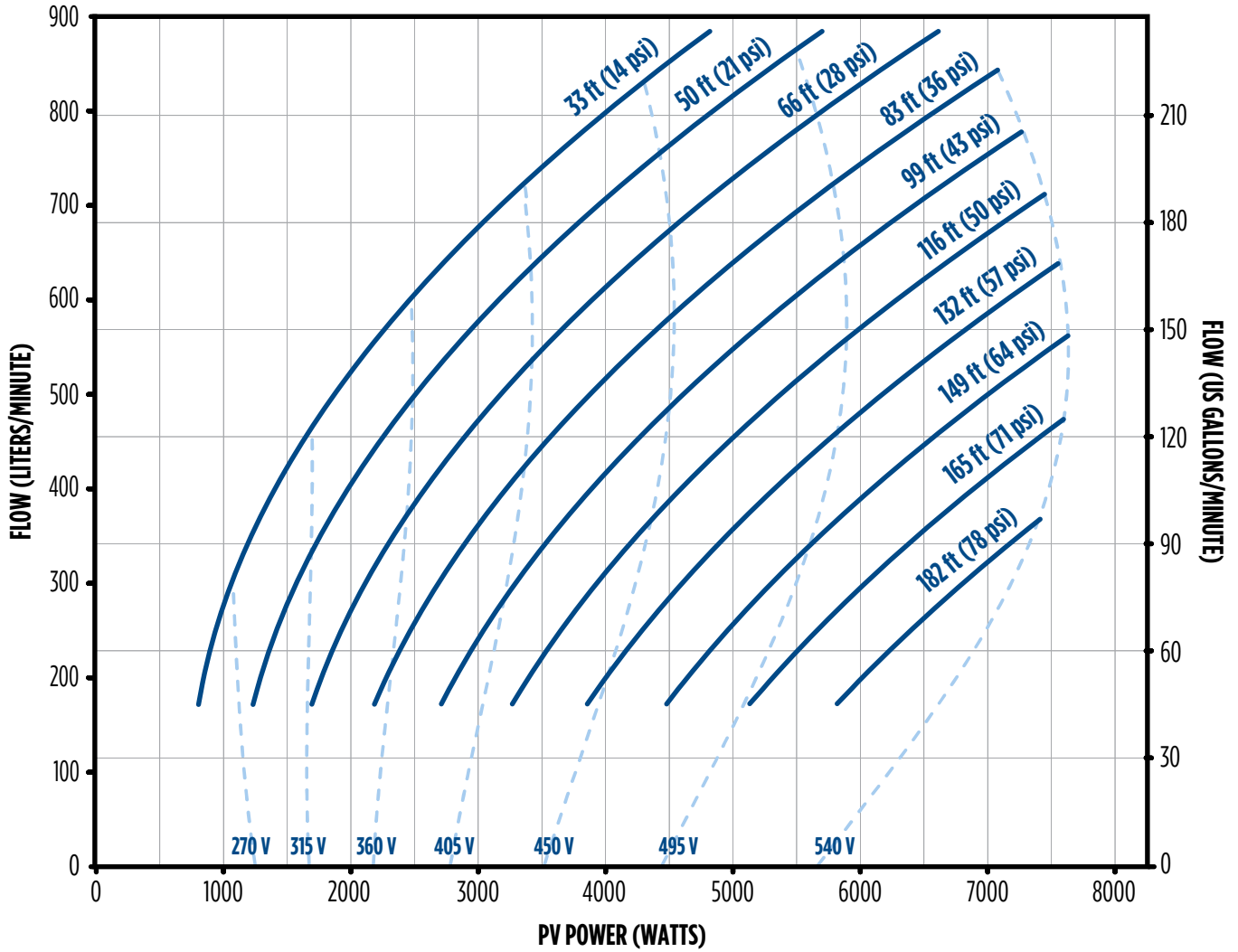

# PHOTON™ SOLARPAK - 7.5 HP (5.5 KW) PERFORMANCE

## 220FDSP-7.5HP

Photon™ Solar 7.5 hp Controller, 220 US gpm 5.0 hp Pump End, 7.5 hp 380 V 3-phase Motor

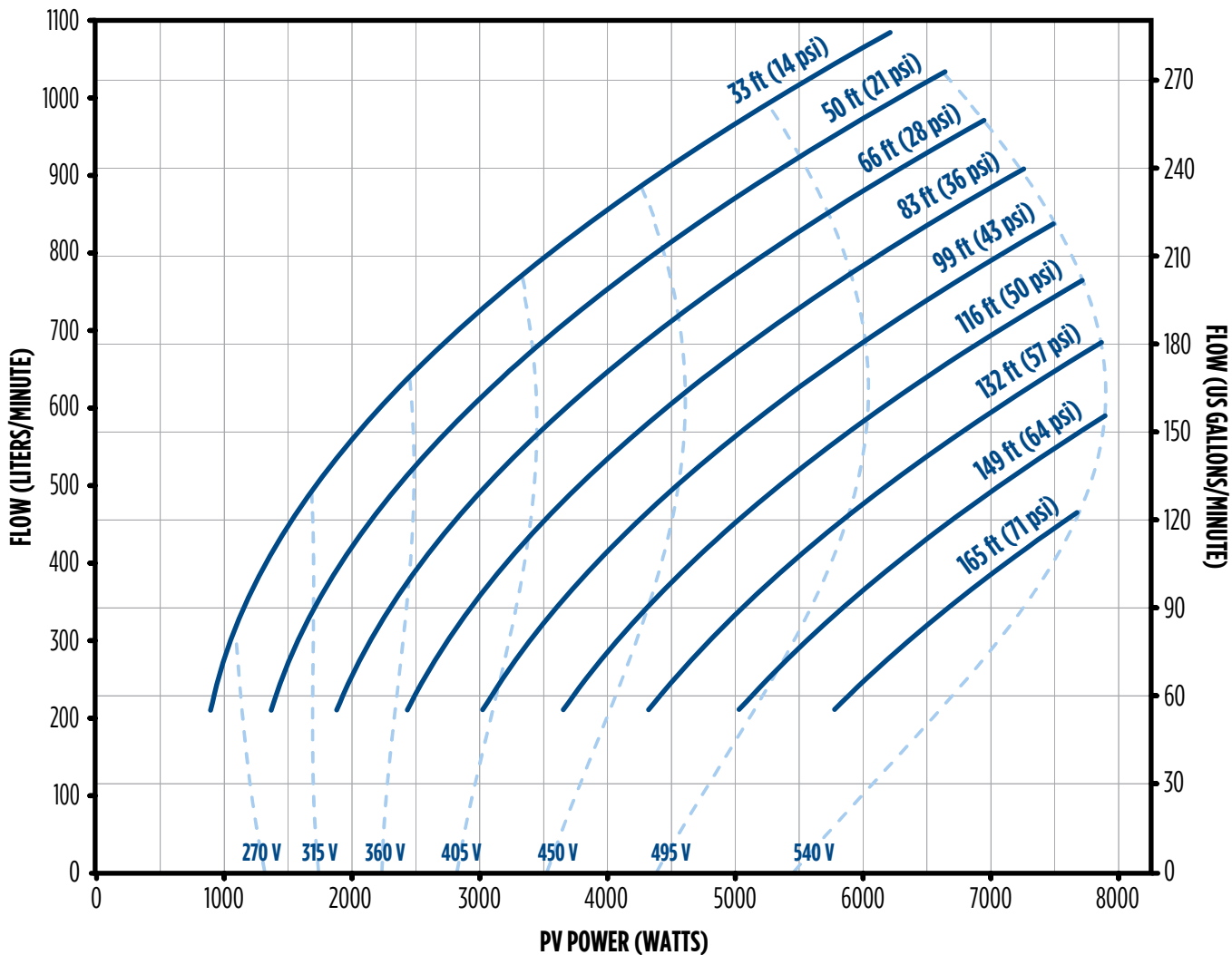



# PHOTON™ SOLARPAK - 7.5 HP (5.5 KW) PERFORMANCE

## 275FDSP-7.5HP

Photon™ Solar 7.5 hp Controller, 275 US gpm 5.0 hp Pump End, 7.5 HP 380 V 3-phase Motor

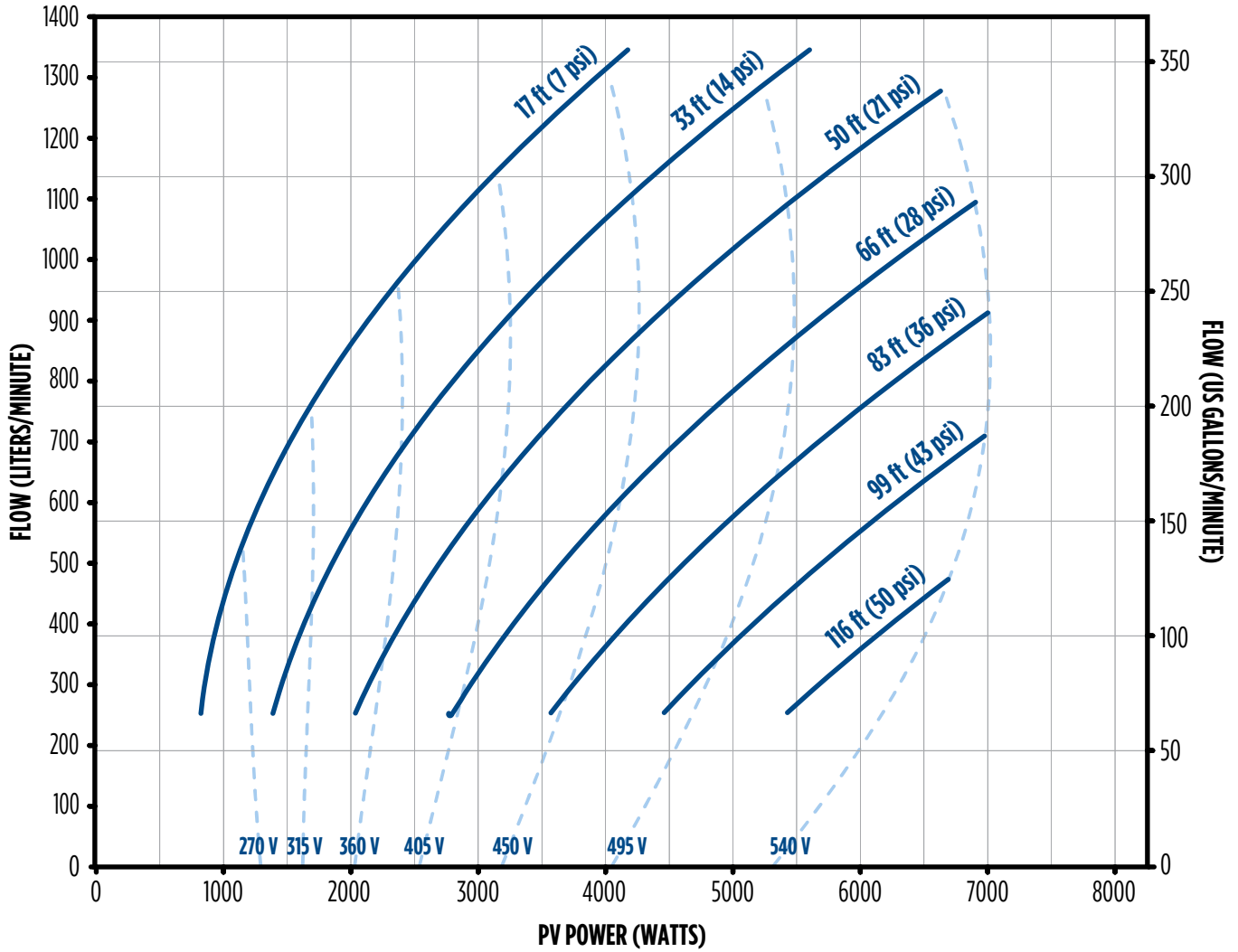

# PHOTON™ SOLARPAK - 7.5 HP (5.5 KW) PERFORMANCE

## 325FDSP-7.5HP

Photon™ Solar 7.5 hp Controller, 325 US gpm 5.0 hp Pump End, 7.5 hp 380 V 3-phase Motor

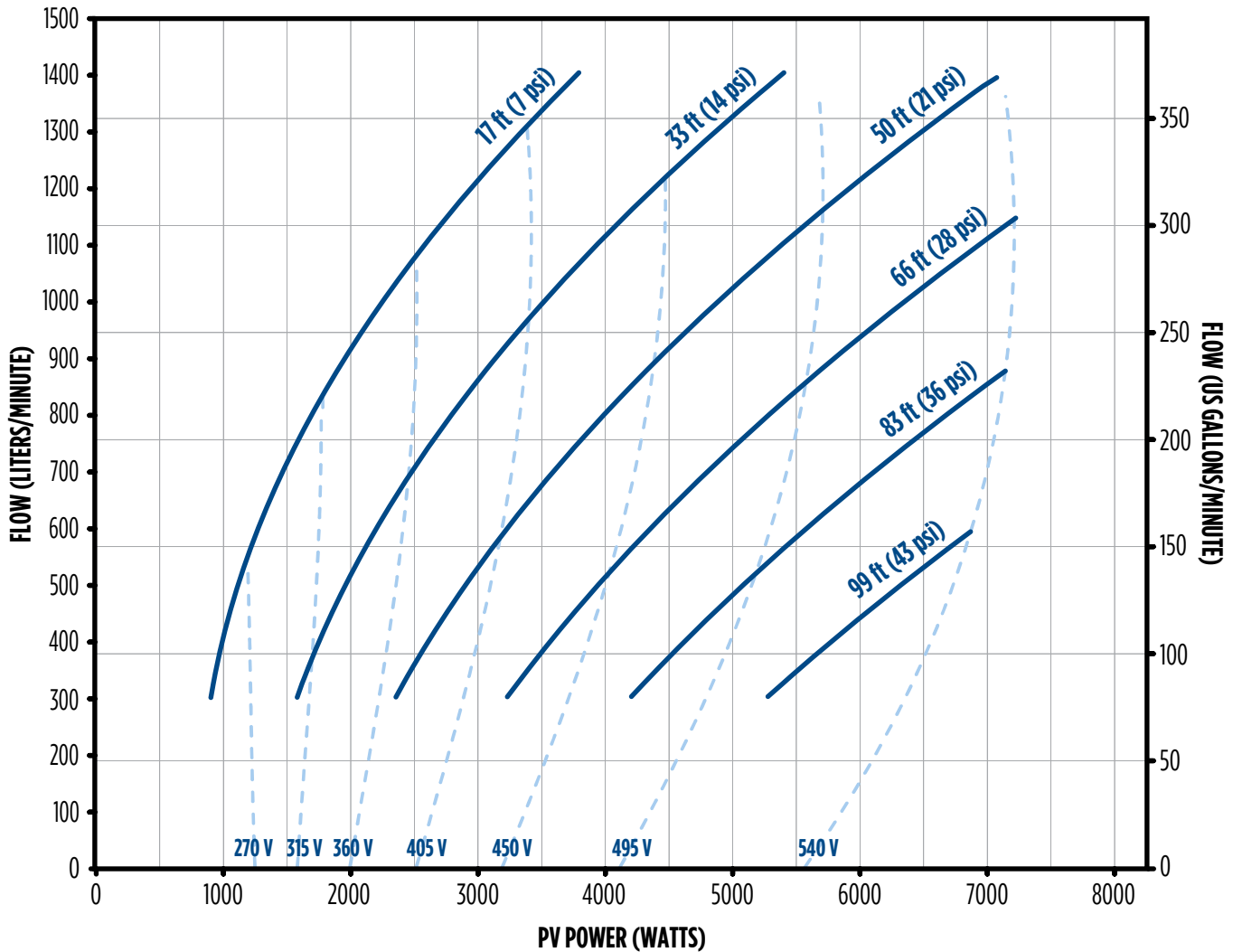

## PHOTON™ SOLARPAK - 7.5 HP (5.5 KW) PERFORMANCE

### 375FDSP-7.5HP

Photon™ Solar 7.5 hp Controller, 375 US gpm 5.0 hp Pump End, 7.5 hp 380 V 3-phase Motor

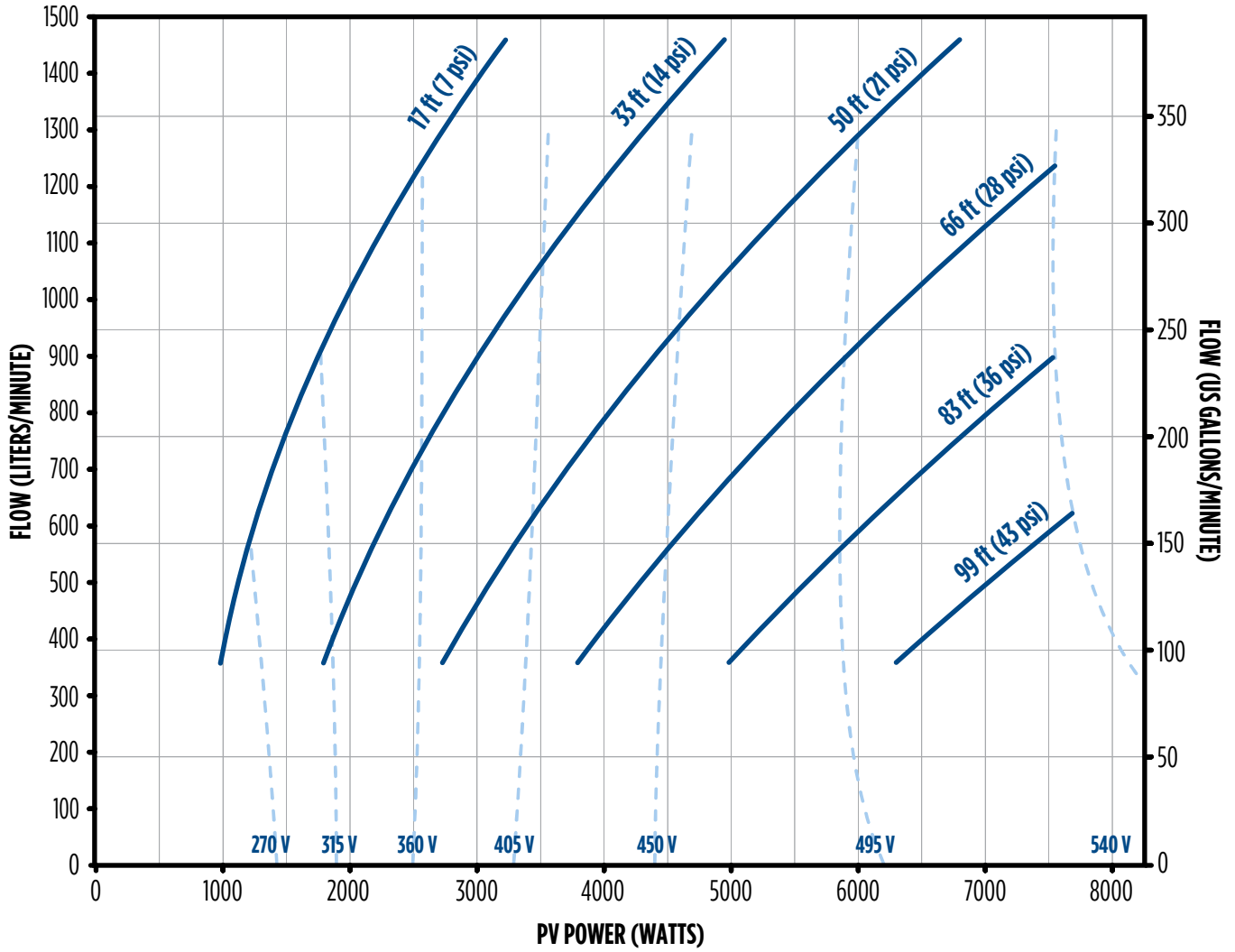

# PHOTON™ SOLARPAK - 10 HP (7.5 KW) PERFORMANCE

## 20FDSP-10HP

Photon™ Solar 10.0 hp Controller, 20 US gpm 10.0 hp Pump End, 10.0 hp 380 V 3-phase Motor

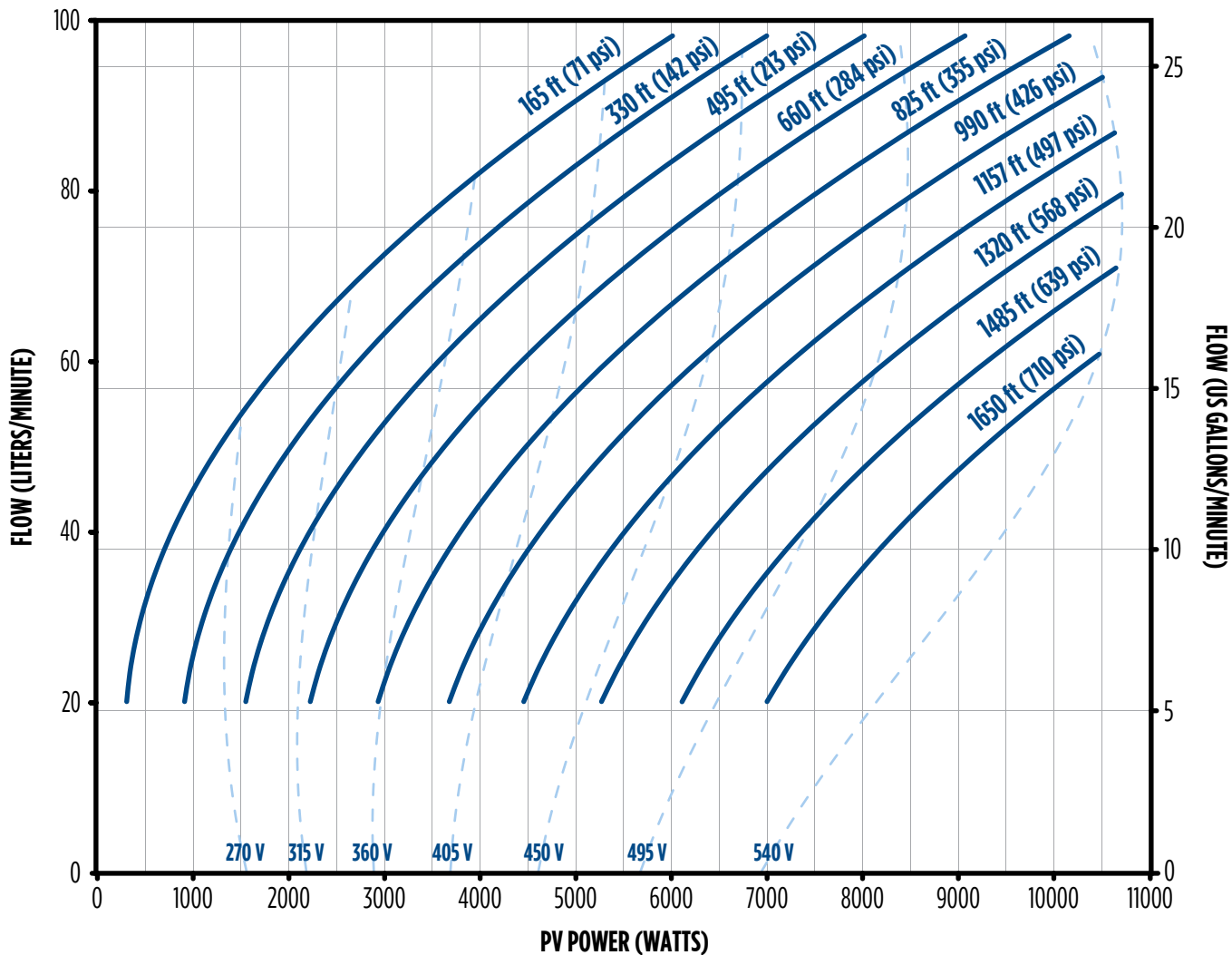

# PHOTON™ SOLARPAK - 10 HP (7.5 KW) PERFORMANCE

## 25FDSP-10HP

Photon™ Solar 10.0 hp Controller, 25 US gpm 10 hp Pump End, 10.0 hp 380 V 3-phase Motor

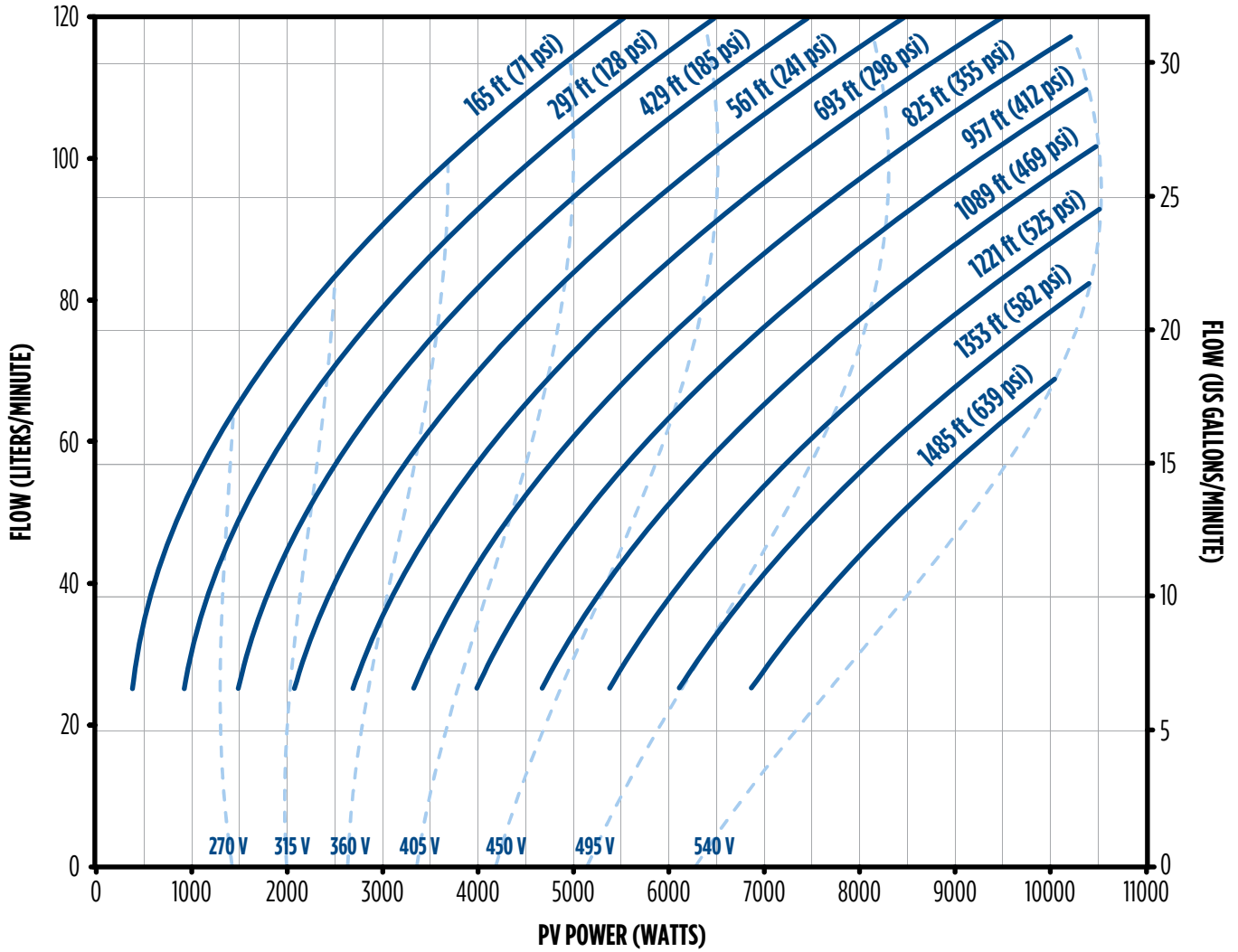

# PHOTON™ SOLARPAK - 10 HP (7.5 KW) PERFORMANCE

## 35FDSP-10HP

Photon™ Solar 10.0 hp Controller, 35 US gpm 10 hp Pump End, 10.0 hp 380 V 3-phase Motor

Basic Model	PEI <sub>c</sub> Number
35S4	0.83

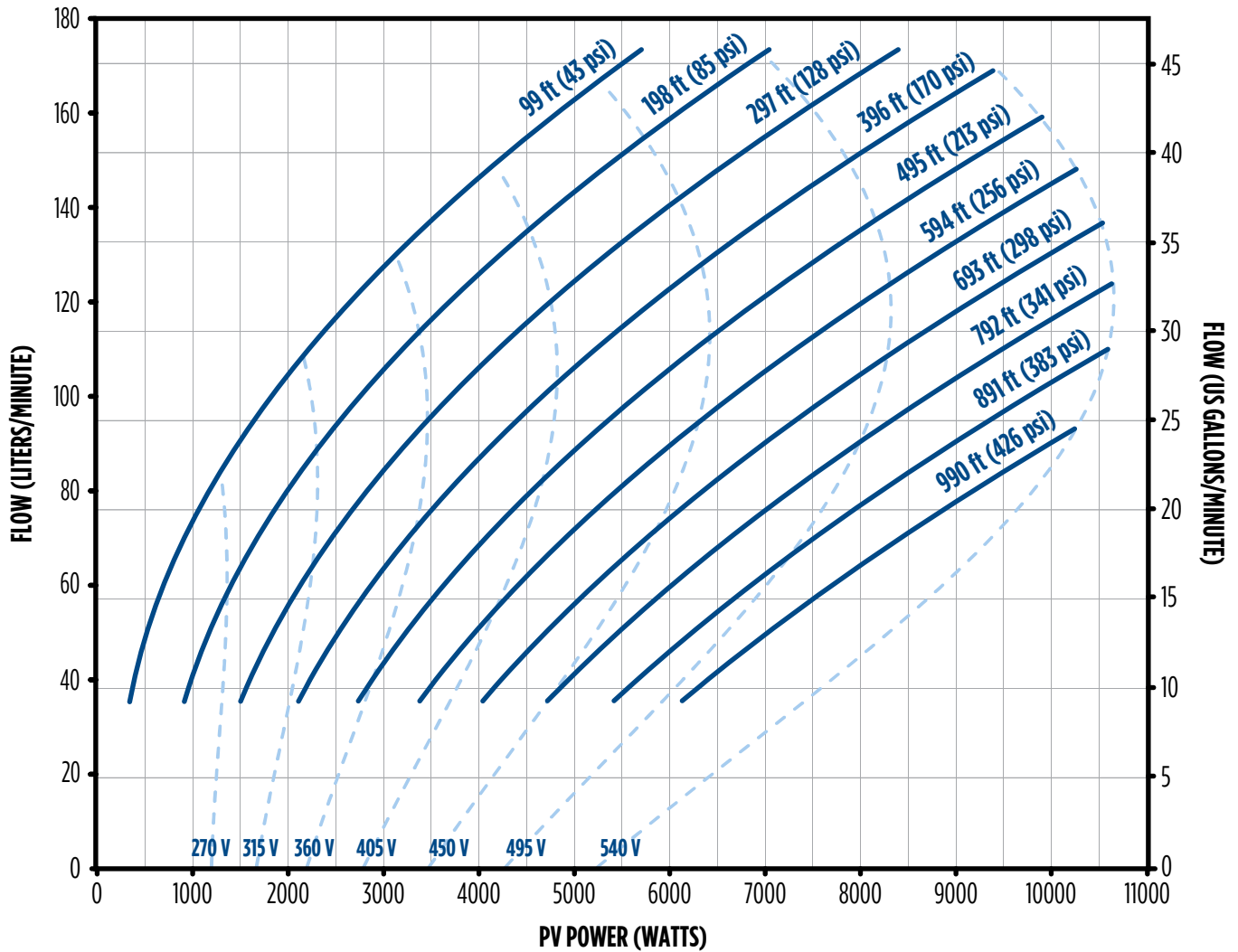

### PHOTON™ SOLARPAK - 10 HP (7.5 KW) PERFORMANCE

#### 45FDSP-10HP

Photon™ Solar 10.0 hp Controller, 45 US gpm 10 hp Pump End, 10.0 hp 380 V 3-phase Motor

Basic Model	PEL <sub>c</sub> Number
45S4	0.89

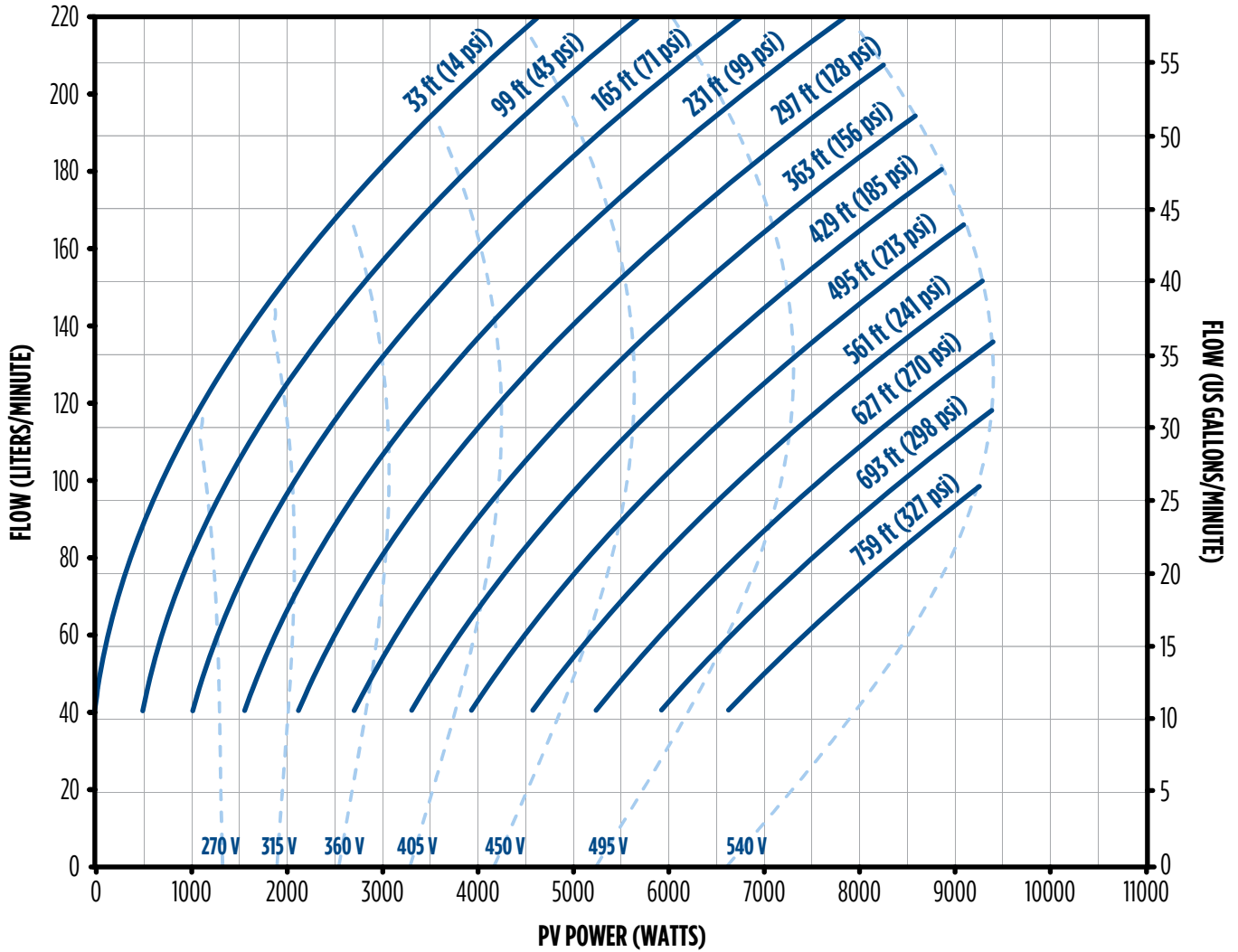

# PHOTON™ SOLARPAK - 10 HP (7.5 KW) PERFORMANCE

## 60FDSP-10HP

Photon™ Solar 10.0 hp Controller, 60 US gpm 10 hp Pump End, 10.0 hp 380 V 3-phase Motor

Basic Model	PEI <sub>c</sub> Number
60S4	0.94

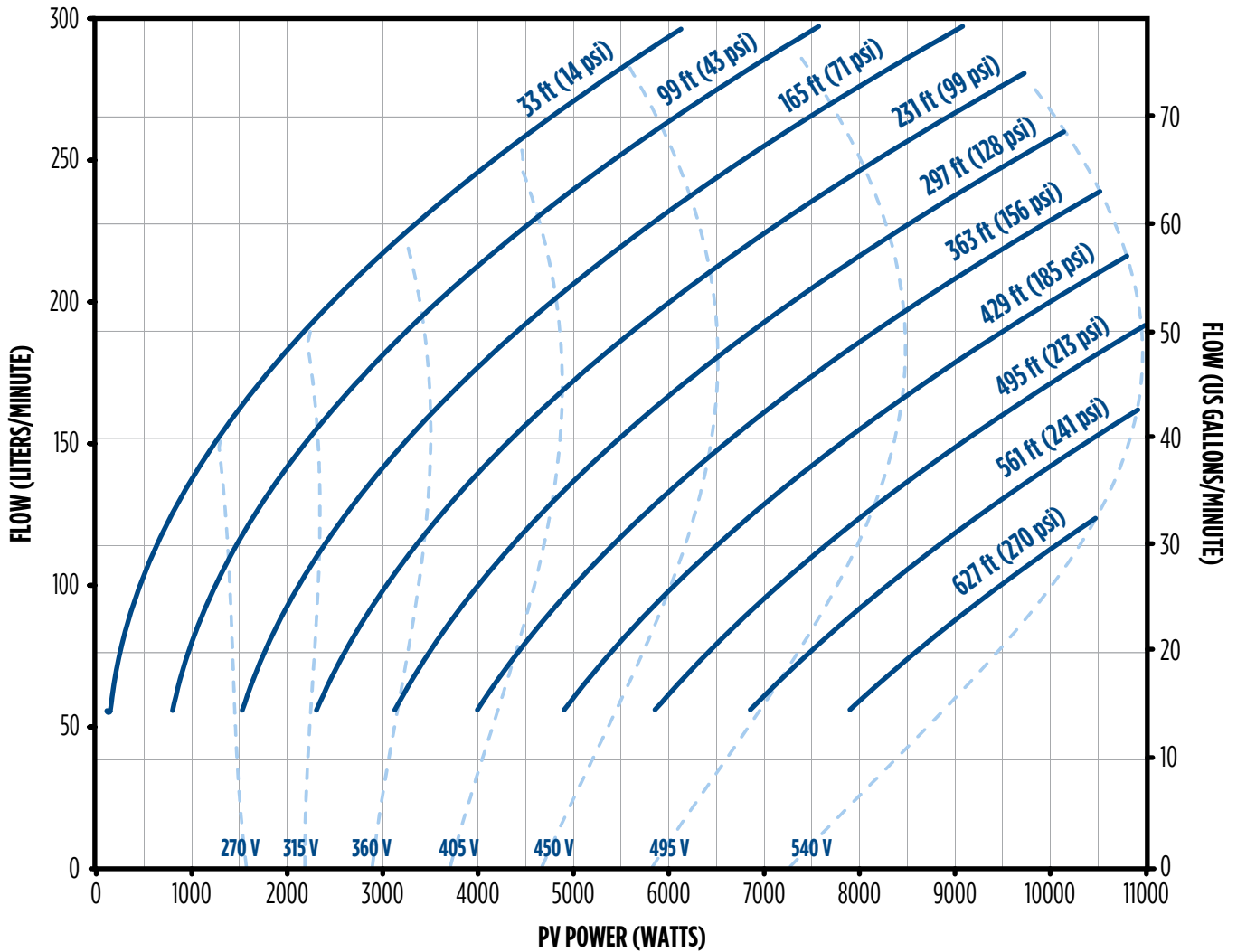



# PHOTON™ SOLARPAK - 10 HP (7.5 KW) PERFORMANCE

## 90FDSP-10HP

Photon™ Solar 10.0 hp Controller, 90 US gpm 10 hp Pump End, 10.0 hp 380 V 3-phase Motor

Basic Model	PEL <sub>c</sub> Number
90S4	0.92

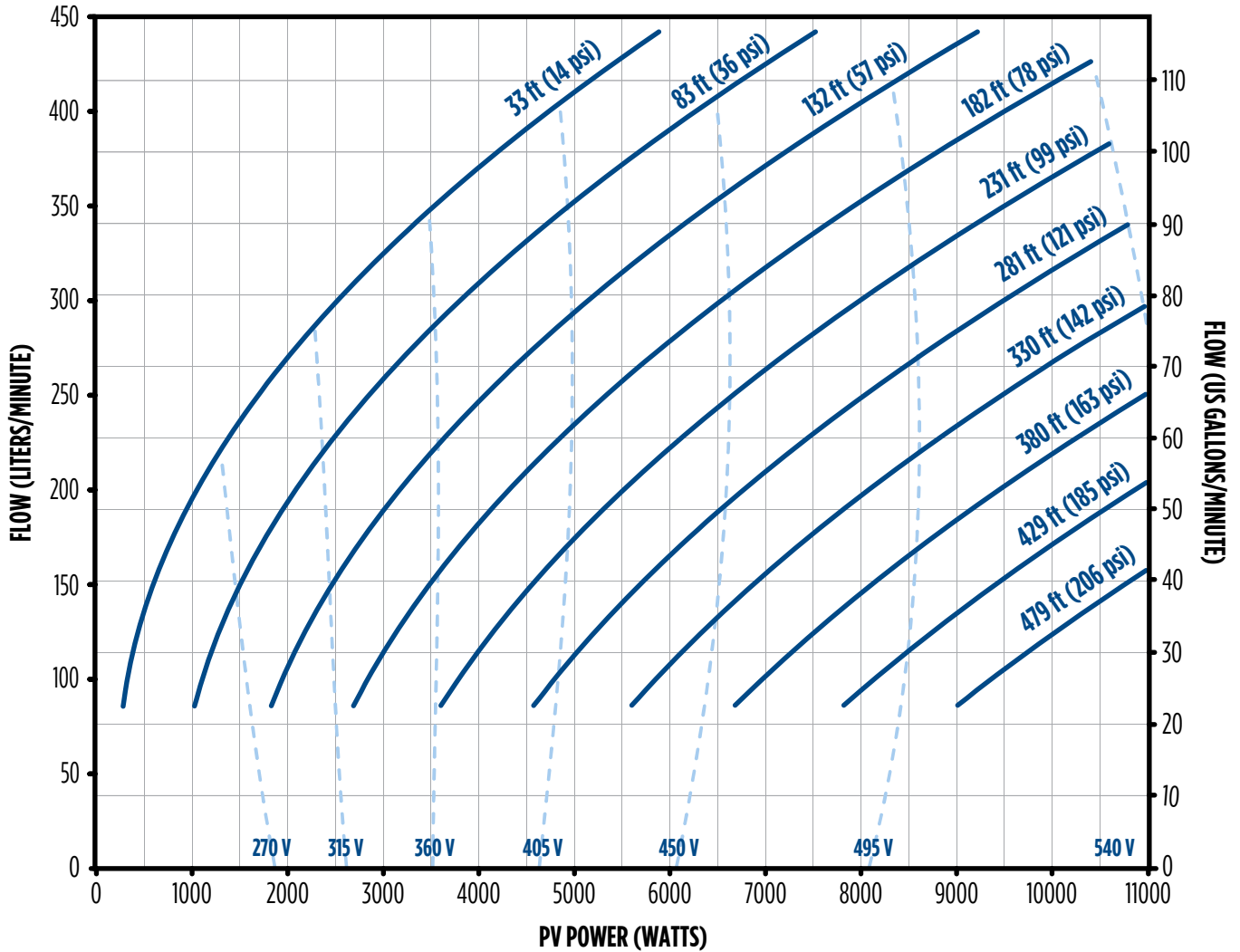

## PHOTON™ SOLARPAK - 10 HP (7.5 KW) PERFORMANCE

100FDSP-10HP

Photon™ Solar 10.0 hp Controller, 100 US gpm 10 hp Pump End, 10.0 hp 380 V 3-phase Motor

Basic Model	PEI <sub>c</sub> Number
100S4	N/A

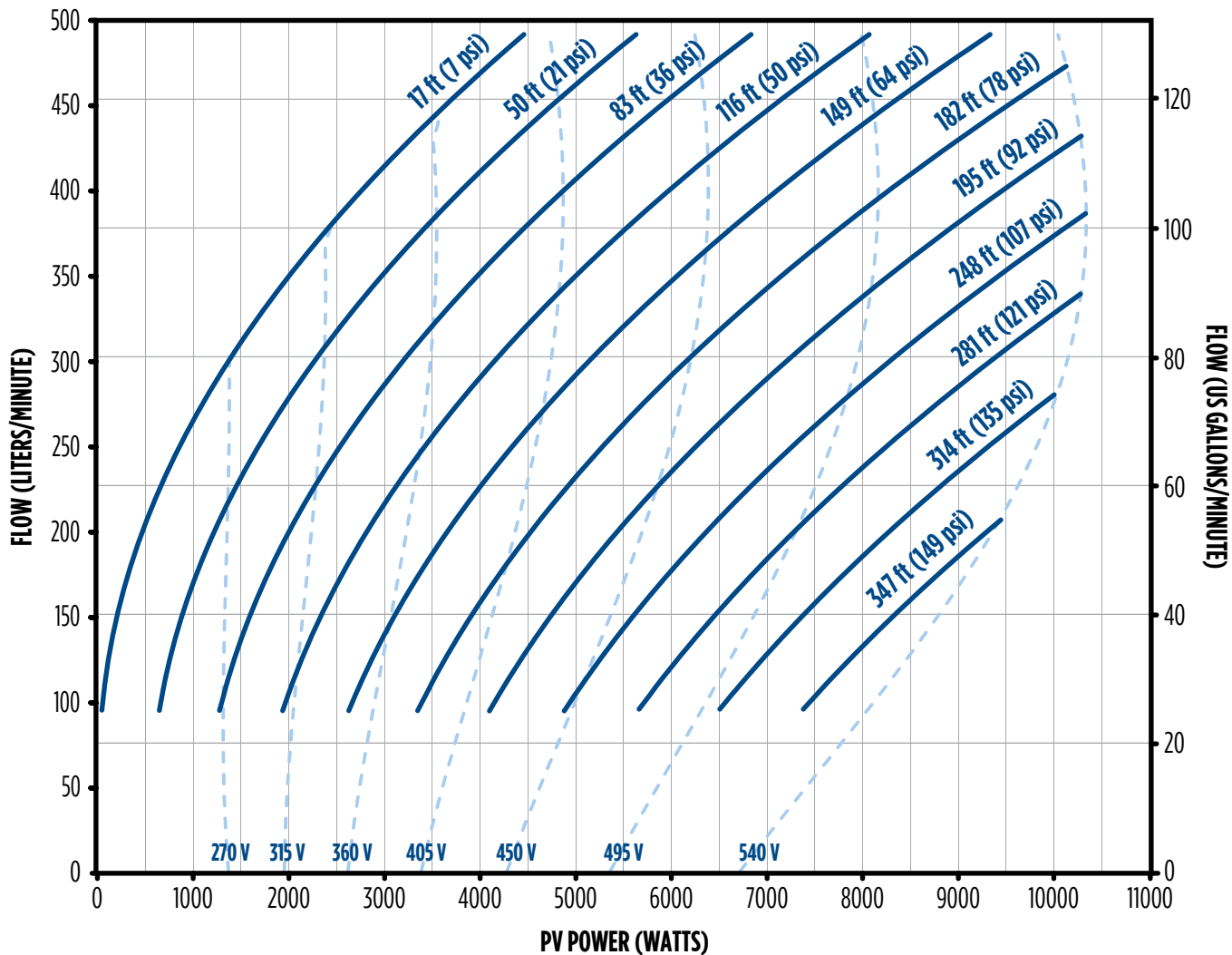

## PHOTON™ SOLARPAK - 10 HP (7.5 KW) PERFORMANCE

### 125FDSP-10HP

Photon™ Solar 10.0 hp Controller, 125 US gpm 10 hp Pump End, 10.0 hp 380 V 3-phase Motor

Basic Model	PEL <sub>CL</sub> Number
125S4	N/A

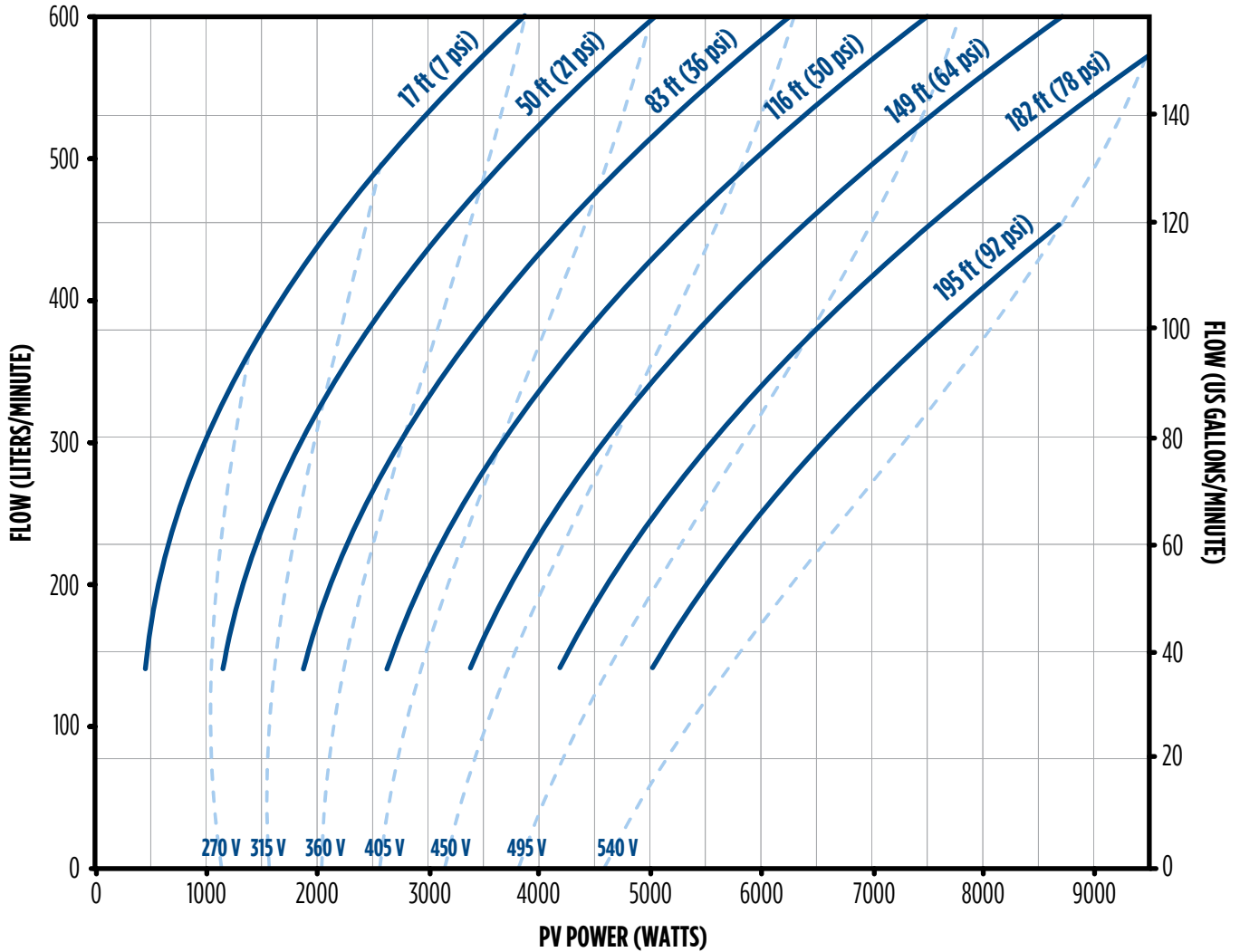

# PHOTON™ SOLARPAK - 10 HP (7.5 KW) PERFORMANCE

## 150FDSP-10HP

Photon™ Solar 10.0 hp Controller, 150 US gpm 10 hp Pump End, 10.0 hp 380 V 3-phase Motor

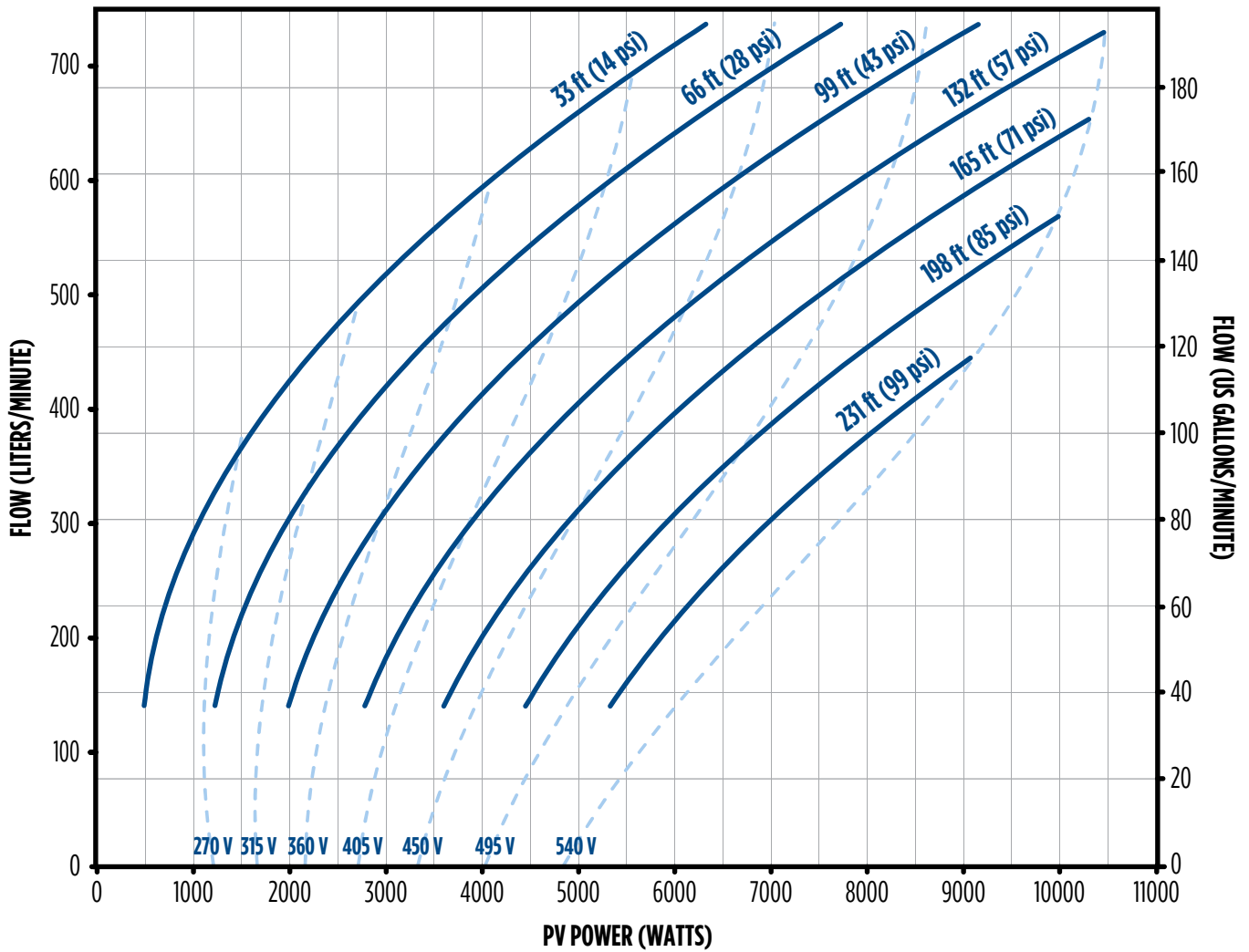

# PHOTON™ SOLARPAK - 10 HP (7.5 KW) PERFORMANCE

## 180FDSP-10HP

Photon™ Solar 10.0 hp Controller, 180 US gpm 10 hp Pump End, 10.0 hp 380 V 3-phase Motor

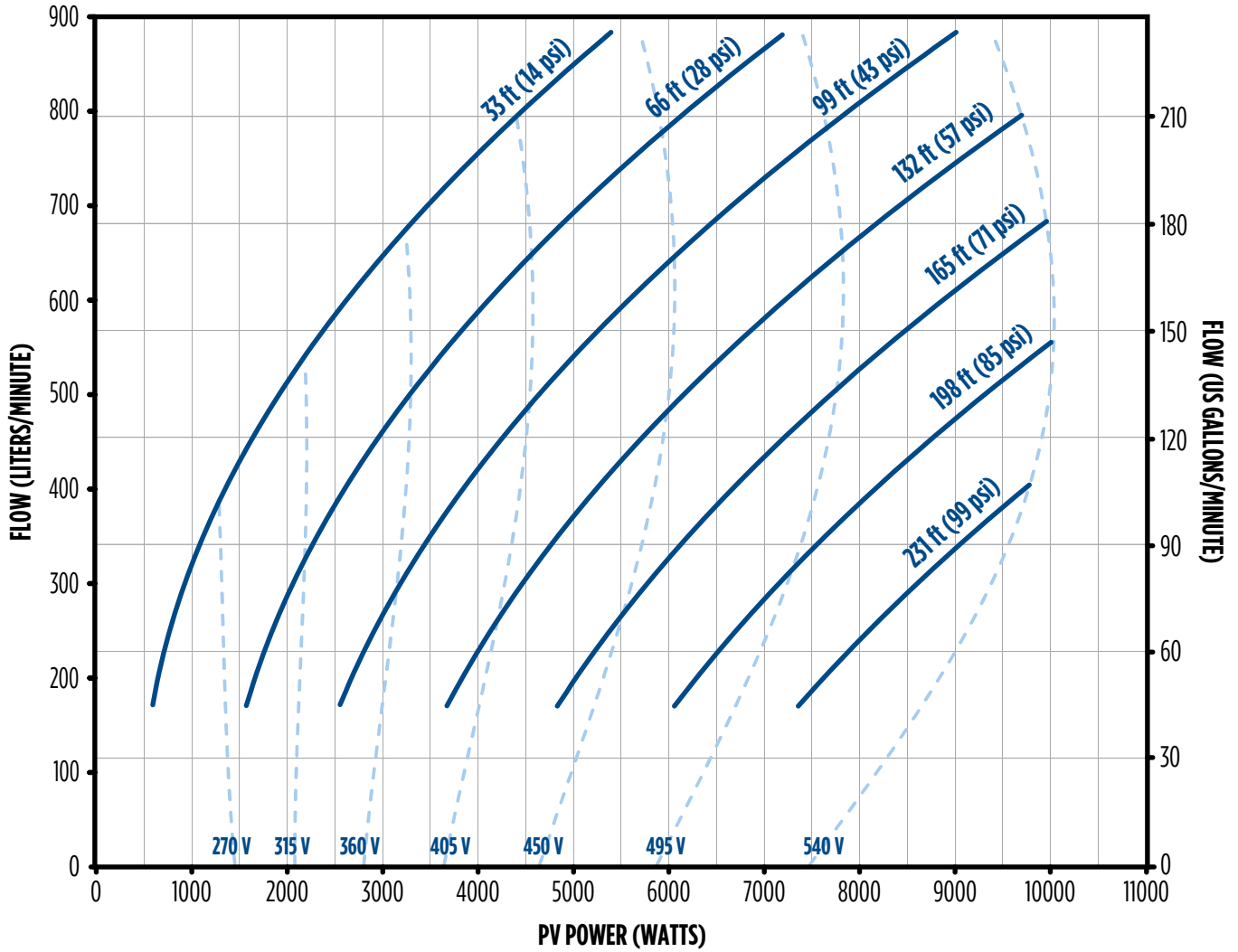

# PHOTON™ SOLARPAK - 10 HP (7.5 KW) PERFORMANCE

## 220FDSP-10HP

Photon™ Solar 10.0 hp Controller, 220 US gpm 10 hp Pump End, 10.0 hp 380 V 3-phase Motor

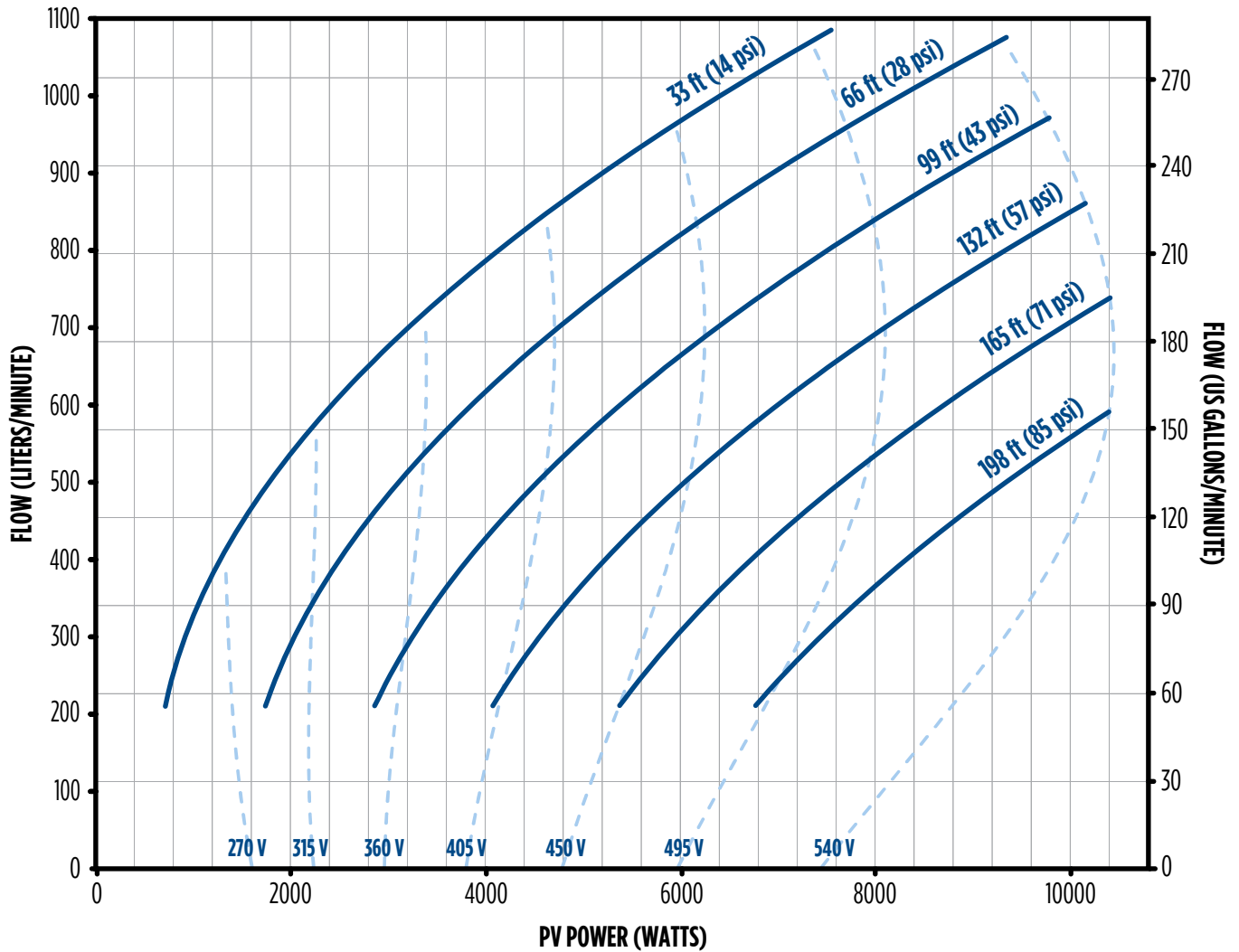

## PHOTON™ SOLARPAK - 10 HP (7.5 KW) PERFORMANCE

### 275FDSP-10HP

Photon™ Solar 10.0 hp Controller, 275 US gpm 10 hp Pump End, 10.0 hp 380 V 3-phase Motor

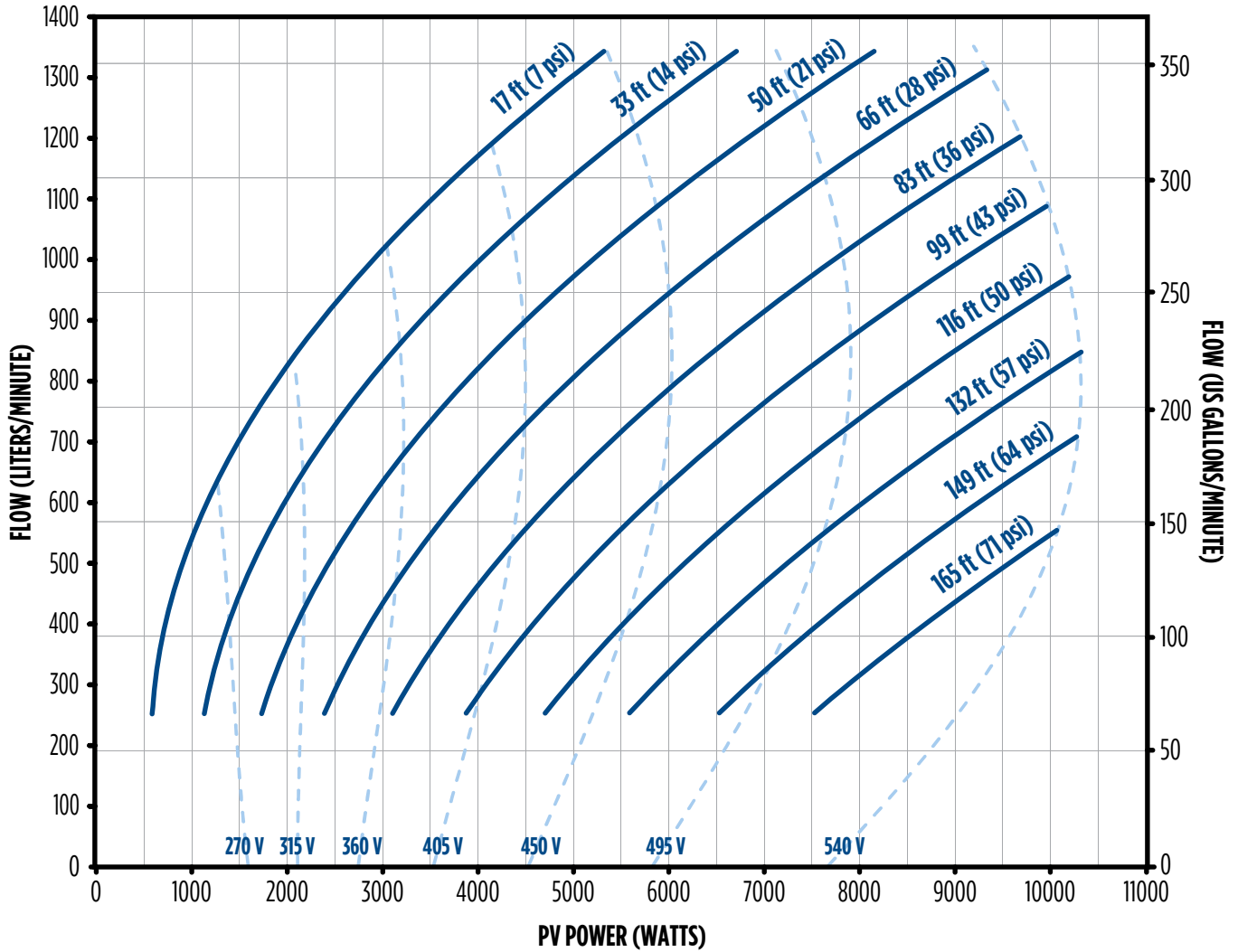

# PHOTON™ SOLARPAK - 10 HP (7.5 KW) PERFORMANCE

## 325FDSP-10HP

Photon™ Solar 10.0 hp Controller, 325 US gpm 10 hp Pump End, 10.0 hp 380 V 3-phase Motor

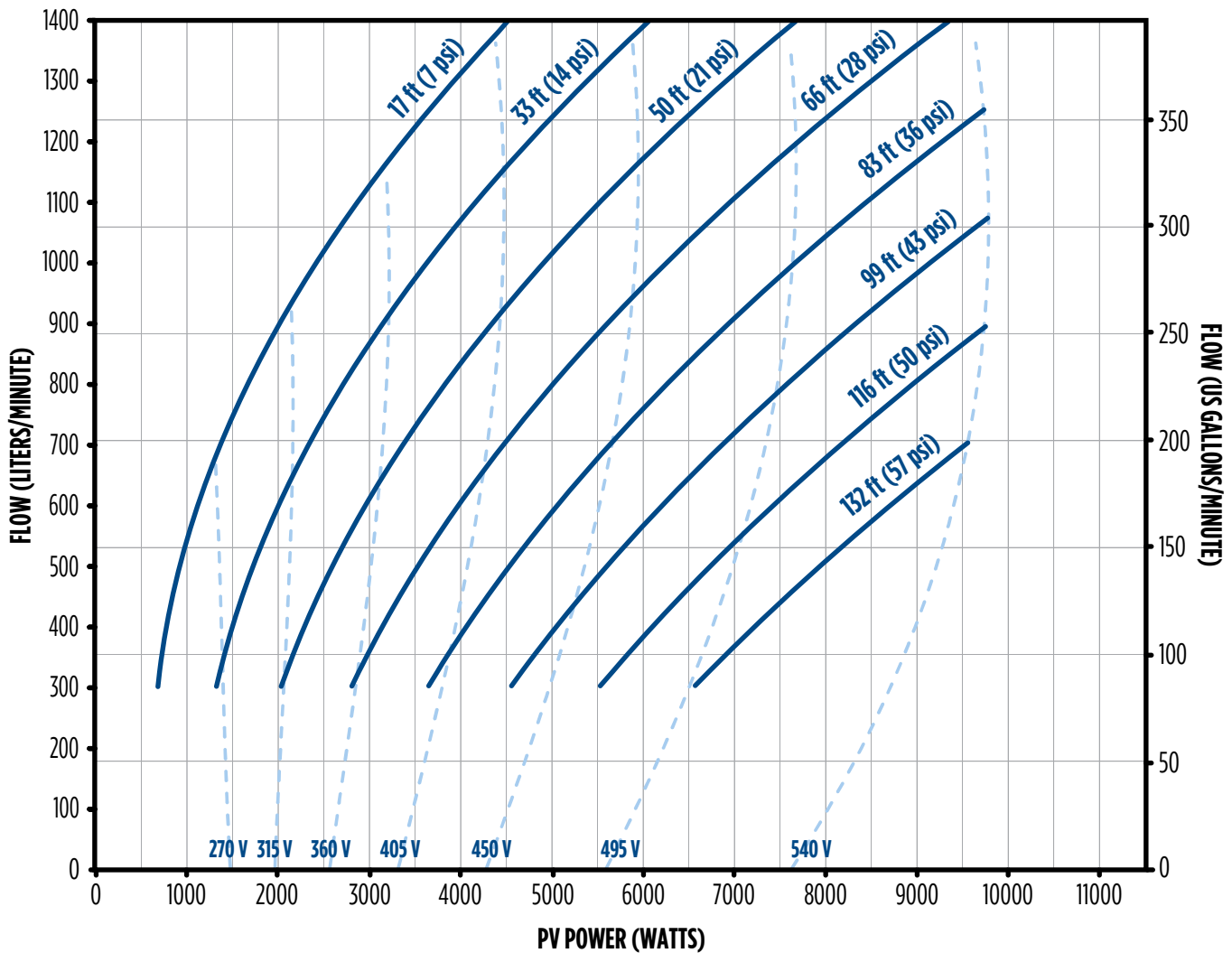



## PHOTON™ SOLARPAK - 10 HP (7.5 KW) PERFORMANCE

### 375FDSP-10HP

Photon™ Solar 10.0 hp Controller, 375 US gpm 10 hp Pump End, 10.0 hp 380 V 3-phase Motor

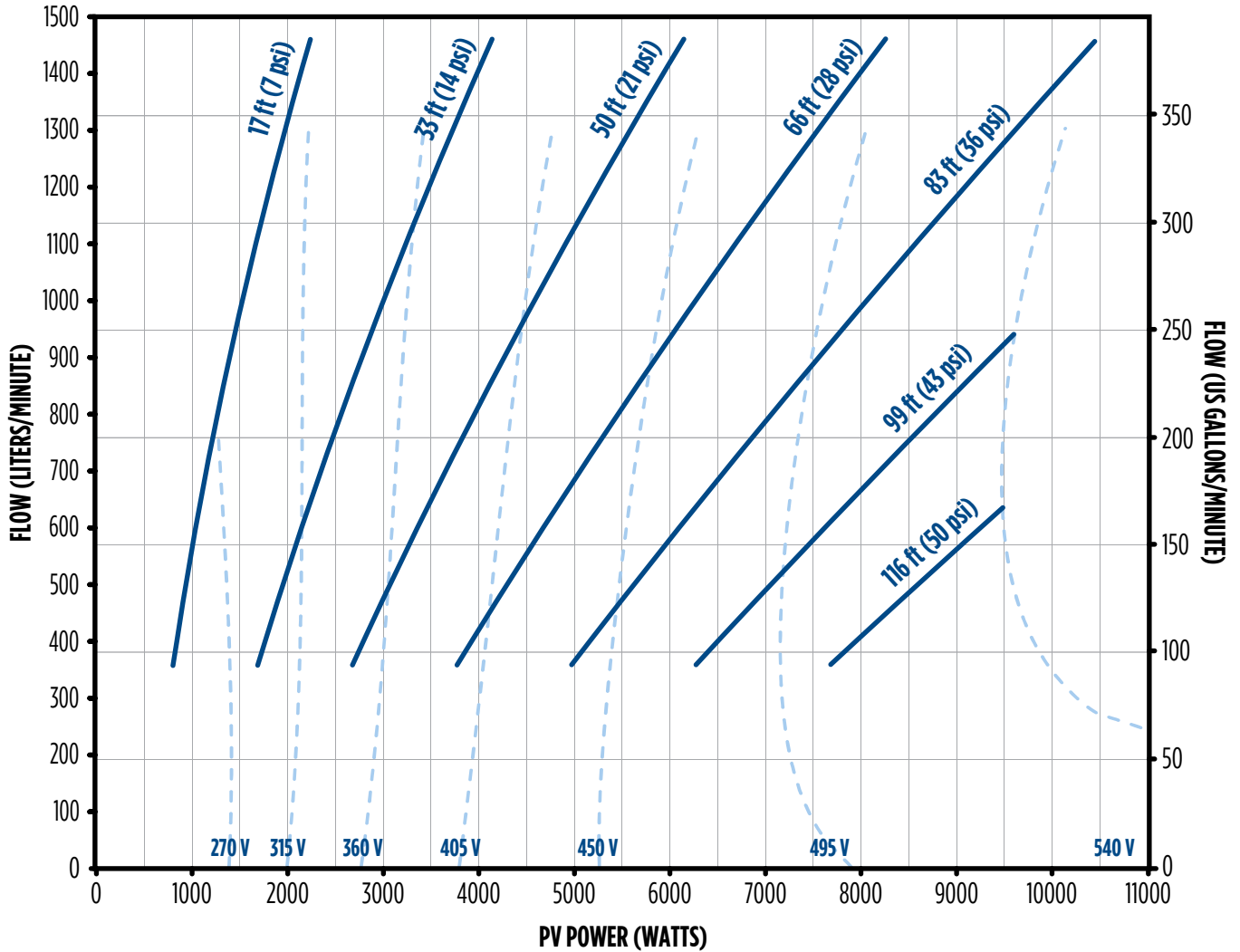

## FHOTON™ SOLARPAK - DIMENSIONS

### SOLAR PMA DIMENSIONS

US GPM	HP	Stages	A		B		C		Discharge	PE Weight		PMA Weight	
			in	mm	in	mm	in	mm		lbs	kg	lbs	kg
10	5	39	37	939.8	29.18	741.172	66.18	1680.97	1-1/4" NPT	23	10.4	-	-
15		31	37	939.8	29.18	741.172	66.18	1680.97		23	10.4	-	-
25		23	37.19	944.63	29.18	741.172	66.37	1685.80		18	8.2	-	-
35		22	35	889.00	29.18	741.172	64.18	1630.17	2" NPT	17	7.7	-	-
45		18	47.75	1212.85	29.18	741.172	76.93	1954.02		25	11.3	-	-
60		13	36.75	933.45	29.18	741.172	65.93	1674.62		21	9.5	-	-
90		12	43.56	1106.42	29.18	741.172	72.74	1847.60	21	9.5	-	-	
100		3	14.62	371.35	29.18	741.172	43.8	1112.52	30	13.6	-	-	
125		2	12.94	328.68	29.18	741.172	42.12	1069.85	3" NPT	29	13.2	-	-
150		2	22.1	561.34	29.18	741.172	51.28	1302.51		62	28.1	135.1	61.3
180		3	28.5	723.90	29.18	741.172	57.68	1465.07		71	32.2	144.3	65.5
220		2	23.7	601.98	29.18	741.172	52.88	1343.15	4" NPT	62	28.1	135.5	61.5
275		1	20.7	525.78	22.9	581.66	43.6	1107.44		61	27.7	150	68
325		2	25.46	646.68	22.9	581.66	48.36	1228.34		73	33.1	162	73.5
375		1	20.71	526.03	22.9	581.66	43.61	1107.69		61	27.7	150	68
20	7.5	39	60.77	1543.56	29.6	751.84	90.37	2295.40	1-1/4" NPT	27	12.2	-	-
25		35	55.88	1419.35	29.6	751.84	85.48	2171.19		25	11.3	-	-
35		34	52.17	1325.12	29.6	751.84	81.77	2076.96	2" NPT	25	11.3	-	-
45		26	65.25	1657.35	29.6	751.84	94.85	2409.19		33	15	-	-
60		17	45.25	1149.35	29.6	751.84	74.85	1901.19		25	11.3	-	-
90		19	64.5	1638.30	29.6	751.84	94.1	2390.14	27	12.2	-	-	
100		5	18.51	470.15	29.6	751.84	48.11	1221.99	3" NPT	32	14.5	-	-
125		3	15.05	382.27	29.6	751.84	44.65	1134.11		30	13.6	-	-
150		3	26.1	662.94	29.6	751.84	55.7	1414.78	70	31.8	156.7	71.1	
180		4	33.3	845.82	29.6	751.84	62.9	1597.66	4" NPT	82	37.2	166.1	75.3
220		4	33.3	845.82	29.6	751.84	62.9	1597.66		82	37.2	166.1	75.3
275		2	25.46	646.68	24.2	614.68	49.66	1261.36		73	33.1	169	76.7
325		2	25.46	646.68	24.2	614.68	49.66	1261.36		73	33.1	169	76.7
375		2	25.46	646.68	24.2	614.68	49.66	1261.36	72	32.7	168	76.2	
20		10	52	76.66	1947.16	32.2	817.88	108.86	2765.04	1-1/4" NPT	35	15.9	-
25	44		66.88	1698.75	32.2	817.88	99.08	2516.63	30		13.6	-	-
35	42		62.23	1580.64	32.2	817.88	94.43	2398.52	2" NPT	31	14.1	-	-
45	31		78.3	1988.82	32.2	817.88	110.5	2806.70		38	17.2	-	-
60	24		61	1549.40	32.2	817.88	93.2	2367.28		31	14.1	-	-
90	24		79.25	2012.95	32.2	817.88	111.45	2830.83	31	14.1	-	-	
100	6		20.49	520.45	32.2	817.88	52.69	1338.33	3" NPT	34	15.4	-	-
125	4		17.13	435.10	32.2	817.88	49.33	1252.98		31	14.1	-	-
150	4		30.1	764.54	32.2	817.88	62.3	1582.42	79	35.8	169.7	77	
180	5		38.1	967.74	32.2	817.88	70.3	1785.62	4" NPT	90	40.8	179.3	81.3
220	5		38.1	967.74	32.2	817.88	70.3	1785.62		90	40.8	179.3	81.3
275	3		30.21	767.33	25.4	645.16	55.61	1412.49		86	39	188	85.3
325	3		30.21	767.33	25.4	645.16	55.61	1412.49		87	39.5	189	85.7
375	2		25.46	646.68	25.4	645.16	50.86	1291.84		72	32.7	176	79.8

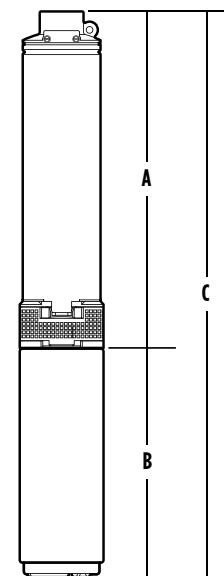

## FHOTON™ SOLARPAK - DRIVE SPECIFICATIONS

### SOLAR CONTROLLER

Controller Model No.	581038501994-XXXXX
Input	
DC (PV)	850 V DC, open circuit
Output	
Max. Output Voltage	Up to 460 V AC, 3-phase
Max. Amps (RMS)	Up to 19.9 A, each phase
Output Frequency	30-60 Hz
Efficiency at Max Power	98 % (approx.)
PV Source	
Max. Input Voltage	*200 - 850 V DC
Max. Amps Input	19.3 A DC, continuous
Max. Input Power	Up to 11.7 kW
Controller Size - L x W x D	
Inches (mm)	15.75" x 12.76" x 9.17" (400 x 324 x 233 mm)
Operating Conditions	
Temperature Range	-25 °C to 50 °C (-13 °F to 122 °F)
Relative Humidity Range	0 to 100% Condensing
Enclosure Rating	Type 4 / IP56

\* See the PV Solar Array Specifications and System Sizing program for indication of adequate array voltage to provide useful pumping capability

## PHOTON™ SURFACE SOLARPAK (1/2–1.5 HP, 0.37–1.1 KW)

Photon™ Surface SolarPAK systems are designed to meet pressure boosting and water transfer needs while running on the power of the sun. Utilizing industry-proven cast iron and stainless steel pumps, systems are available in a range of horsepower sizes that offer high performance solar pumping for a wide variety of applications. Whether boosting water pressure from a cistern tank, solar fountain, or other surface source, Franklin's quality solar products will fit your renewable energy needs.

### APPLICATIONS

- Turf Irrigation
- Water Transfer
- Pressure Boosting
- Water Circulation
- Fountains
- Wash Down Applications
- Animal Hydration
- Commercial Water Features
- Rain Water Harvesting
- General Purpose Pumping



### SURFACE SOLARPAK CONTENTS

- Photon™ solar controller
- Franklin Electric pump and motor
- Low flow cut-off switch

### SURFACE SOLARPAK NOMENCLATURE

**FDSP - X.XHP - XX**

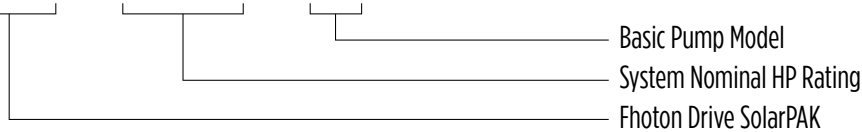

## SURFACE SOLARPAK - ORDERING INFORMATION

### SURFACE SOLARPAK MODEL NUMBERS (NPT)

SolarPak		Photon™ Solar Controller		Surface Pump/Motor (NPT)			Flow Switch (NPT)	
SolarPak Model	Order No.	Drive Model	Part No.	Type	Model	Part No.	Model	Flow Switch
FDSP-0.5HP-7BT4	91040725	FD Solar 1.1 kW N4	581014200864-14IB000	Booster	7FBT05S4-T	95830755	C25	226014102
FDSP-1.5HP-30MH	91143025	FD Solar 1.1 kW N4	581014200864-14IB001	Booster	30FMH2S5-T	96063013	F21	226019102
FDSP-1HP-FCE	91240025	FD Solar 1.1 kW N4	581014200864-14IC000	End Suction	FCE1CI-T	90203010	F21	226019102
FDSP-1.5HP-TB	91340025	FD Solar 1.1 kW N4	581014200864-14IA000	Self-Priming	FTB15CI-SSI-T	92983015	F21	226019102

## PHOTON™ SURFACE SOLARPAK - 0.5–1.5 HP PERFORMANCE

### FDSP-0.5HP-7BT4

Photon™ Solar 1.5 hp Controller, 0.5 hp 7 US gpm BT4 Pump and Motor (208-230 V, 3-PH, 60 Hz)

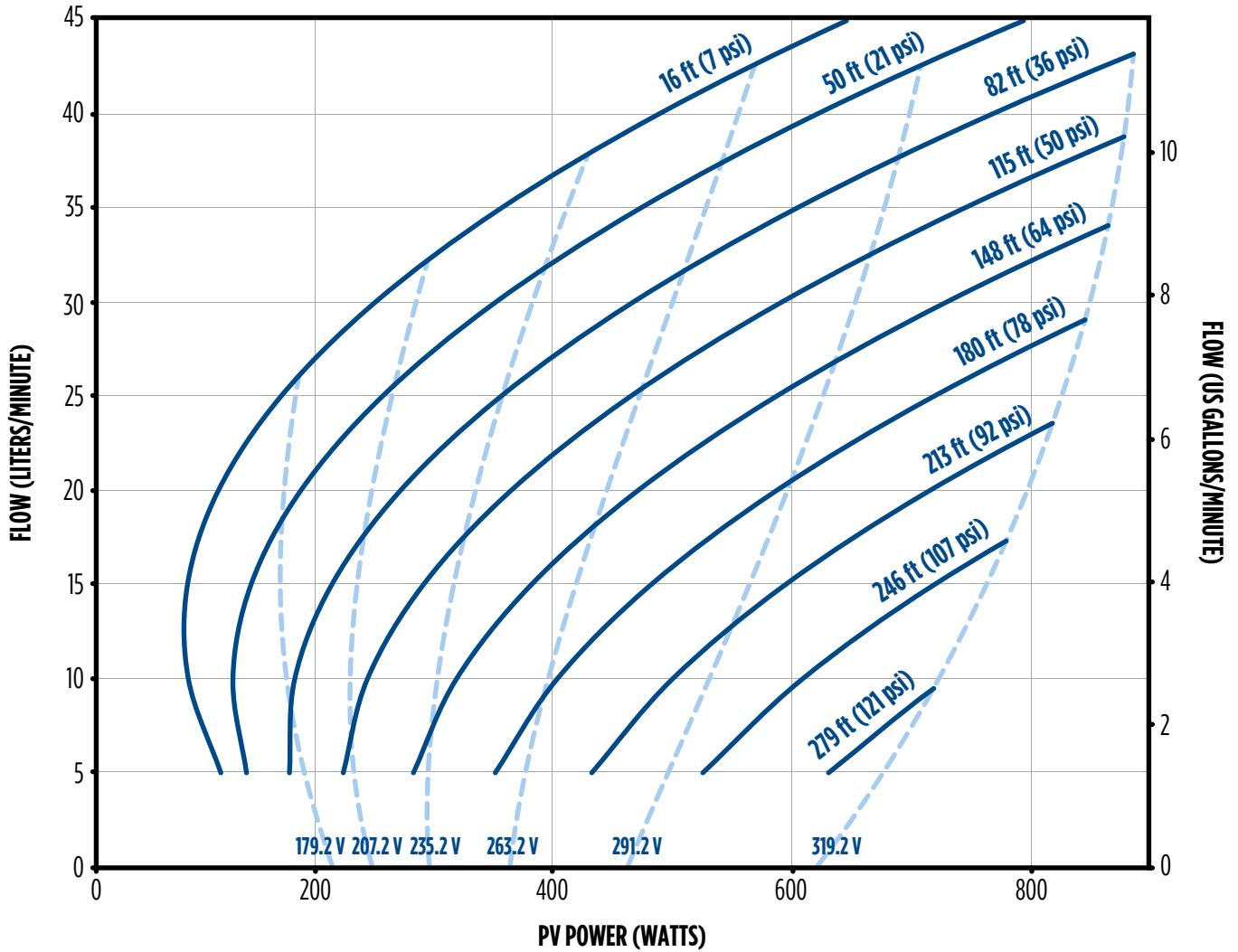

## PHOTON™ SURFACE SOLARPAK - 0.5–1.5 HP PERFORMANCE

### FDSP-1HP-FCE

Photon™ Solar 1.5 hp Controller, 1 hp FCE Pump and Motor (208-230 V, 3-PH, 60 Hz)

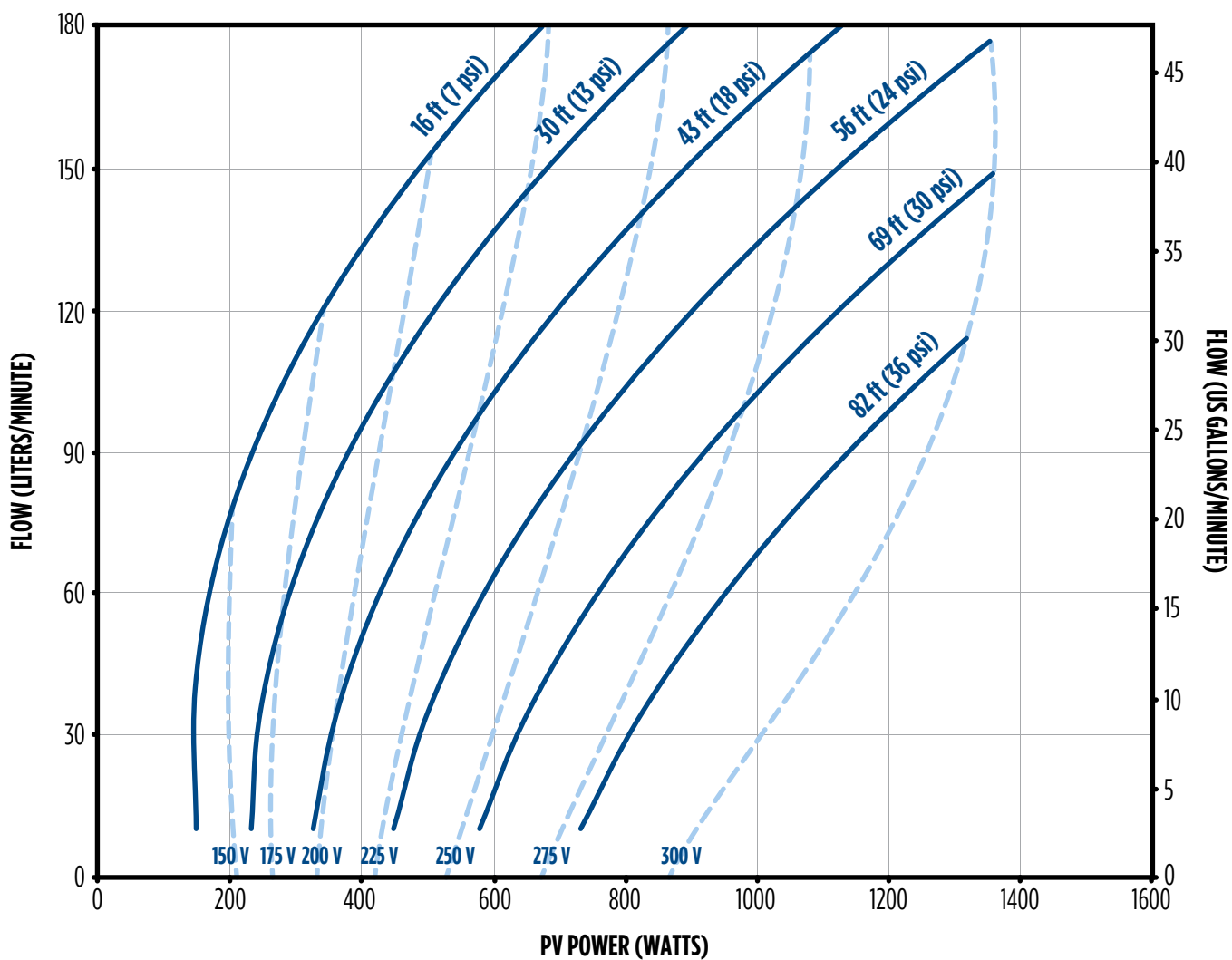

## PHOTON™ SURFACE SOLARPAK - 0.5–1.5 HP PERFORMANCE

### FDSP-1.5HP-30MH

Photon™ Solar 1.5 hp Controller, 2 hp 30 US gpm MH Pump and Motor (208-230 V, 3-PH, 60 Hz)

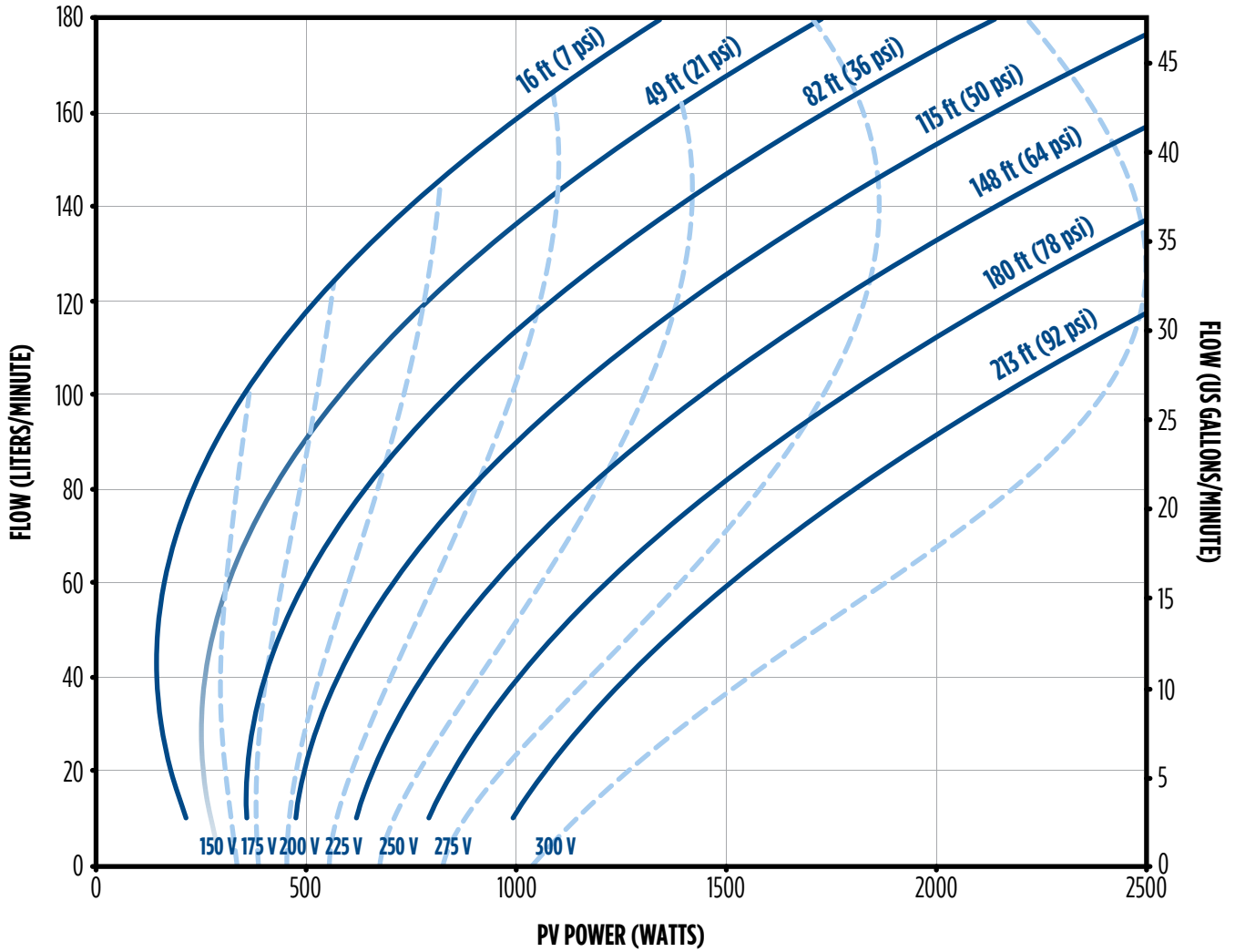

# PHOTON™ SURFACE SOLARPAK - 0.5-1.5 HP PERFORMANCE

## FDSP-1.5HP-TB

Photon™ Solar 1.5 hp Controller, 1.5 hp Turf Boss Pump and Motor (208-230 V, 3-PH, 60 Hz)

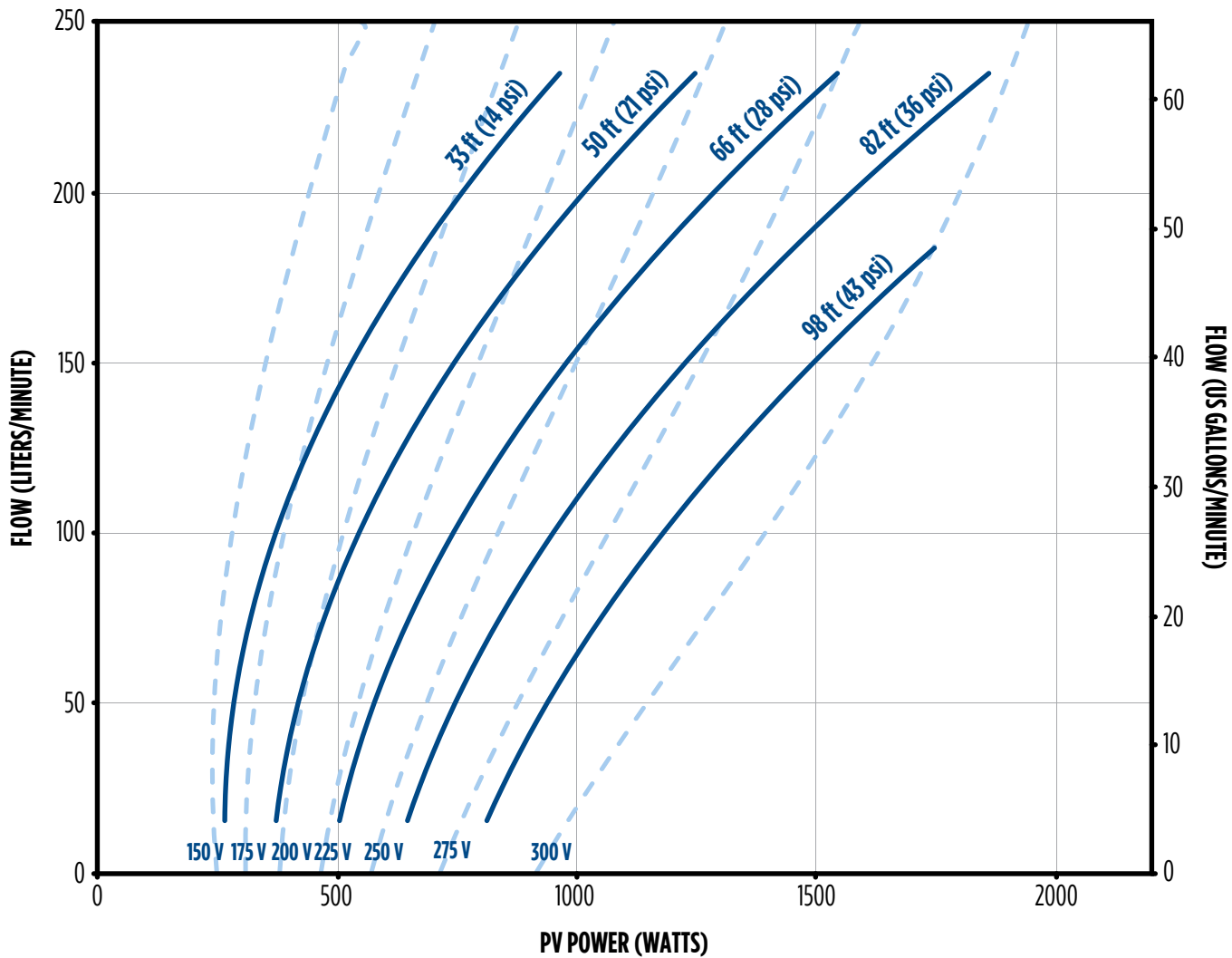



## PHOTON™ SURFACE SOLARPAK - DIMENSIONS

### SURFACE SOLAR DIMENSIONS

Model	HP	kW	PH	Dimensions										PMA Weight	
				A*		B*		C*		Discharge		Suction		lbs	kg
				in	mm	in	mm	in	mm	in	mm	in	mm		
7FBT05S4-T	0.5	0.37	3	24.69	627	9.09	231	4.09	104	1	25	1	25	37	16.8
30FMH2S5-T	2	1.5	3	21.61	549	8.00	203	4.00	102	1	25	1 1/4	32	43	19.5
FCEICI-T	1	0.75	3	15.57	395	8.90	226	4.00	102	1	25	1 1/4	32	34	15.5
FTBISCI-SSI-T	1.5	1.1	3	25.00	635	8.87	225	7.27	185	1 1/2	38	1 1/2	38	55	25.0

\* Pump image is not representative of all products and is for general reference only; A = Length, B = Height, C = Vertical distance to center of suction line

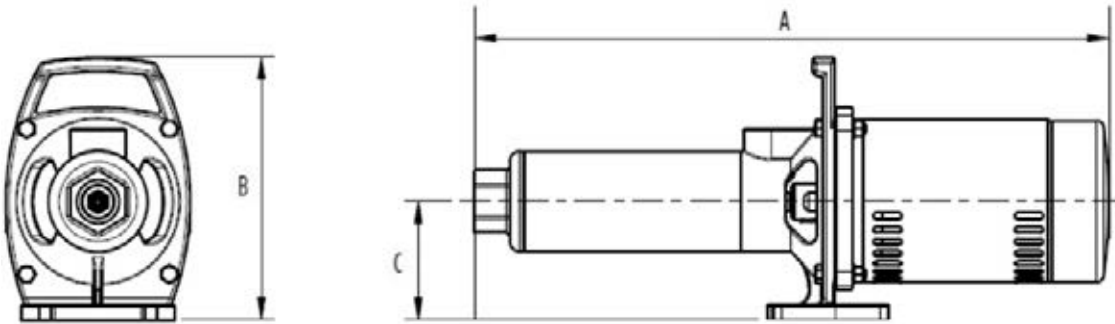

### SURFACE SOLAR CONTROLLER DIMENSIONS

Photon™ Solar Controller	Applicable Pump	Motor Rating	Drive Input Voltage	Controller Size (in/mm)		
				L	W	D
581013000864-141B000	BT4 7 gpm 1/2 hp	1/2 hp, 208-230 V 3Ph 60 Hz, 1.9 SF	115-420 VDC	6.28/159.5	6.28/159.5	7.32/185.93
581013000864-141B001	MH 30 gpm 2 hp	2 hp, 208-230 V 3Ph 60 Hz, 1.3 SF	115-420 VDC	6.28/159.5	6.28/159.5	7.32/185.93
581013000864-141C000	FCE 1 hp	1 hp, 208-230 V 3Ph 60 Hz, 1.65 SF	115-420 VDC	6.28/159.5	6.28/159.5	7.32/185.93
581013000864-141A000	MH 30 gpm 2 hp	1.5 hp, 208-230 V 3Ph 60 Hz, 1.3 SF	115-420 VDC	6.28/159.5	6.28/159.5	7.32/185.93

## ACCESSORIES

### AC/DC POWER CONVERTER

- Option for use with all Photon drive models up to 1.5 hp
- Accepts either AC (single-phase) or DC power source\*
  - 115 V AC for use with 3-phase, 100 V Franklin Electric submersible motor
  - 230 V AC for use with 3-phase, 200 V Franklin Electric submersible motor
- Converter box output power becomes the input source supplying the Photon solar drive
- Output short circuit protection
- Type 4 indoor/outdoor rated enclosure for durability
- UL & CE rated
- Optional communication module

\*Source power from a single-phase generator, grid-tie AC source, or DC source; can pair with manual- or auto-crossover switch



Model	Description
581114204	AC/DC Power Converter, Solar Drive

### DC DISCONNECT & OTHER ACCESSORIES

Item	Order No.	Description	Shipping Information	
			Size (LxWxH)	Wt. (lbs)
DC Disconnect	305709035	Safety Switch IP66, 600Vdc 25A 2-Pole	4.5" x 4.0" x 7.25"	1.25
Mounting bracket	226944901	Mounting bracket for Photon VFD or AC/DC unit	10.5" x 7.13" x 7"	1.5
Comm. Card	581COMM-APP	Wi-Fi Module for Photon VFDs	13.5" x 3.5" x 3.5"	0.5

\*Solar Panel Mounting System requires one, 4.0" SCH40, steel pipe as a horizontal cross support beam; this is to be cut to length based on number and type of solar panel

\*\*Electrical specification data is solar industry STC



## ACCESSORIES

### PV PANELS w/RACKS & ACCESSORIES

No. of Panels	Order No.	Description	Pole size required* (Qty.)	PV Panel type (Included in kit)	PV Panel (ea.)				
					Watts**	Vmpp**	Voc**	LxWxH	Wt. (lbs)
2	305709015	2-SolarPV-60cell-KIT	4" SCH40 (1)	60-cell (Mono-PERC)	300W+	32V	40V	65" x 39" x 1.6"	40.1 lbs
3	305709000	3-SolarPV-60cell-KIT	4" SCH40 (1)						
4	305709001	4-SolarPV-60cell-KIT	4" SCH40 (1 or 2)						
5	305709002	5-SolarPV-60cell-KIT	4" SCH40 (2)						
6	305709003	6-SolarPV-60cell-KIT	4" SCH40 (2)						
7	305709004	7-SolarPV-60cell-KIT	4" SCH40 (3)						
8	305709005	8-SolarPV-60cell-KIT	4" SCH40 (3)						
9	305709006	9-SolarPV-60cell-KIT	4" SCH40 (3)						
10	305709007	10-SolarPV-60cell-KIT	4" SCH40 (4)						
11	305709008	11-SolarPV-60cell-KIT	4" SCH40 (4)						
12	305709009	12-SolarPV-60cell-KIT	4" SCH40 (4)						



\*Includes Solar (PV) panels, Pole-mount racks for PV panels, 600V DC-rated disconnect, connection wire for use between the panels and disconnect & between disconnect and solar VFD, ground wire and bonding equipment, galvanized ground rod and clamps

### SOLAR (PHOTOVOLTAIC) PANELS

No. of Panels	Order No.	Description	Panel type	PV Panel (ea.)				
				Watts**	Vmpp**	Voc**	LxWxH	Wt. (lbs)
1	305709030	1-SolarPV-72cell	72-cell	320W+	37V	46V	77" x 39" x 1.6"	49.6 lbs
25	305709052	25-SolarPV-72cell	(Polycrystalline)					



### MOUNTING RACKS

No. of PV panels	Order No.	Description	Pole size required* (Qty.)	Shipping Information	
				Size (LxWxH)	Wt. (lbs)
2	305709045	2-SolarPV-Rack	4" SCH40 (1)	36" x 10" x 10"	21
3	305709046	3-SolarPV-Rack	4" SCH40 (1)		23
4	305709047	4-SolarPV-Rack	4" SCH40 (1 or 2)		30
5	305709048	5-SolarPV-Rack	4" SCH40 (2)		33
6	305709049	6-SolarPV-Rack	4" SCH40 (2)		39



# INSTALLATION QUICK REFERENCE

## DIMENSIONAL GUIDE FOR MOUNTING RACKS

Using (1) 4" SCH40 vertical pole	
No. panels	Cross pipe length (L):
2	7.5 ft
3	11 ft
4	15 ft

Using (2) 4" SCH40 vertical pole		
No. panels	Cross pipe length (L):	Dist. between poles (D):
4	15 ft	10 ft
5	18.5 ft	12 ft
6	22 ft	10 ft

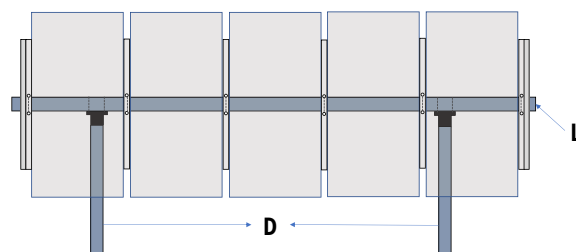
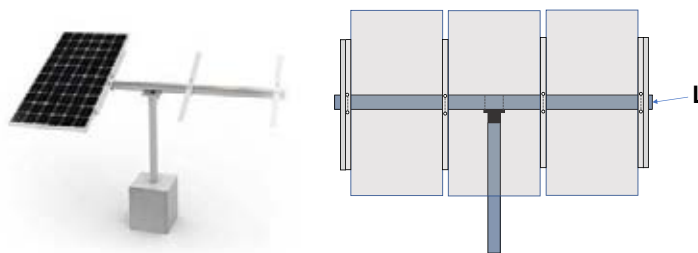

Example DC Disconnect with 1 string (typ. up to 600V)

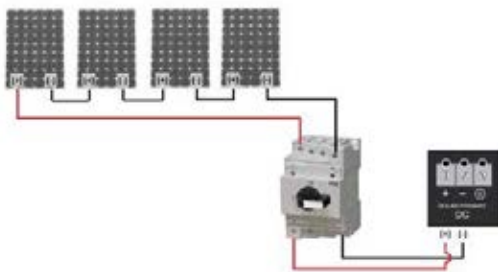

Example DC Disconnect with 1 string (typ. up to 800V)

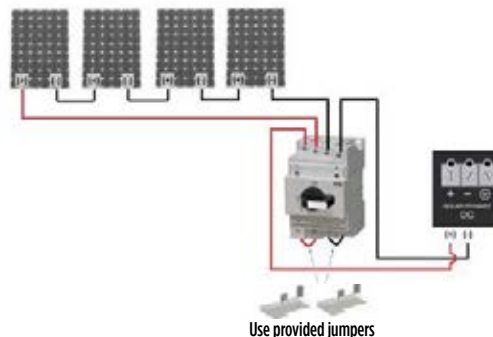

Example DC Disconnect with 2 strings (typ. up to 600V)

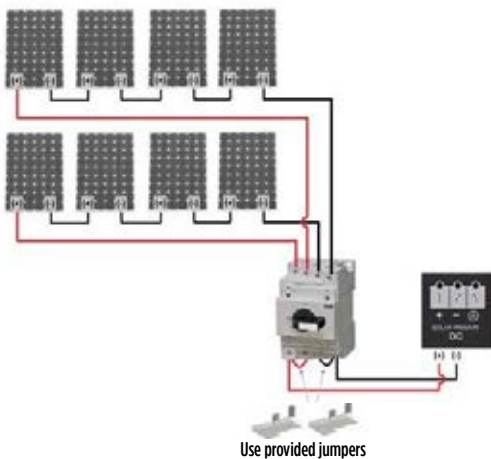

# INSTALLATION QUICK REFERENCE

## SOLARPAK INSTALLATION

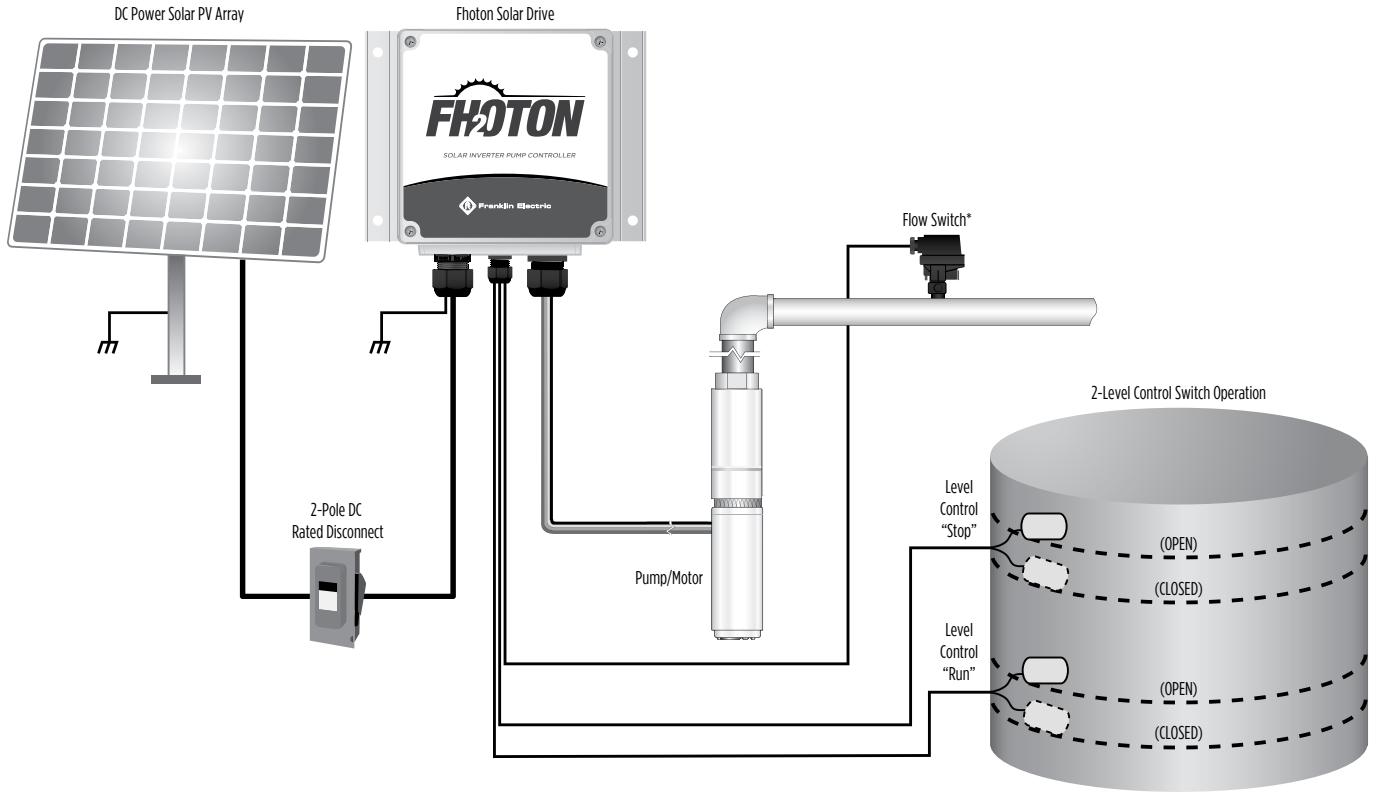

\* When required or included





