

DrivE-Tech

MINI-Solar



Ideal for any kind of solar pumping application

It ensures:

- New solar pumping systems creation.
- Conversion of existing systems into solar pumping systems.
- Control of both three-phase and single-phase pumps.
- Soft start and soft stop.
- Installation on humid and dusty environments made possible by IP66 (NEMA 4X) protection degree.
- Easy and fast commissioning thanks to initial configuration wizard.
- High thermal and mechanical performance thanks to aluminium case and independent ventilation.



MPPT: always the maximum power available

Based on the varying conditions of solar irradiation and temperature, MPPT (Maximum Power Point Tracking) maximises the electrical power drawn from the panels and therefore the amount of water pumped. The greater the solar irradiation the faster the pump's rotation speed, and consequently water flow increases.

When solar irradiation decreases (due to clouds or the different times of day), the pump reduces frequency and therefore the flow, but it continues to provide water until the irradiation falls below a minimum level necessary to ensure operation.

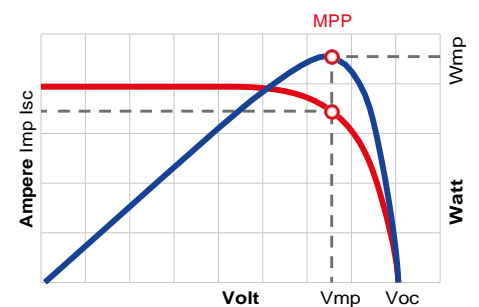

MIDA Solar can be used with any type of traditional AC pump, thereby offering maximum flexibility in several areas of application.

When using surface pumps, MIDA Solar can be used for an irrigation system drawing water from a nearby water supply, or powering a pool pump at no cost.

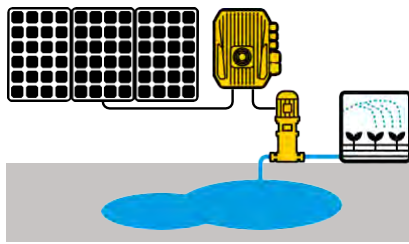

When using submersible pumps, MIDA Solar can fill tanks for watering livestock or simply irrigate lawns or crops.

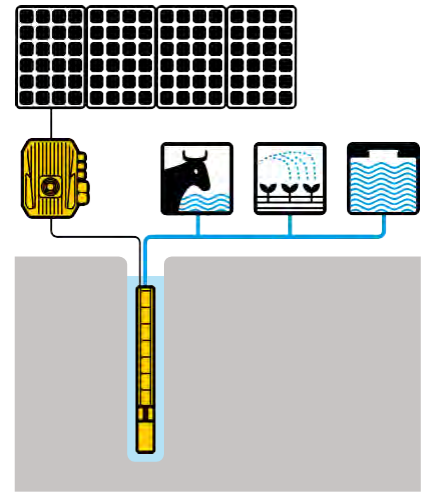
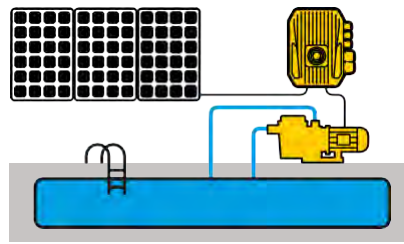

MIDA Solar, in MP (MultiPower) version, can be powered in DC by solar panels or in AC by network or generator

to ensure the functioning of the pump at any hour of the day. This controls the peaks of water demand using AC input to avoid the oversizing of the photovoltaic system. HMA accessory,

used in combination with MIDA Solar MP models, manages independently the exchange from a source of energy to another on the basis of several options that can be select by the user:

- irradiance level
- hour of the day
- achievement of the requested daily range
- remote control trough digital command.

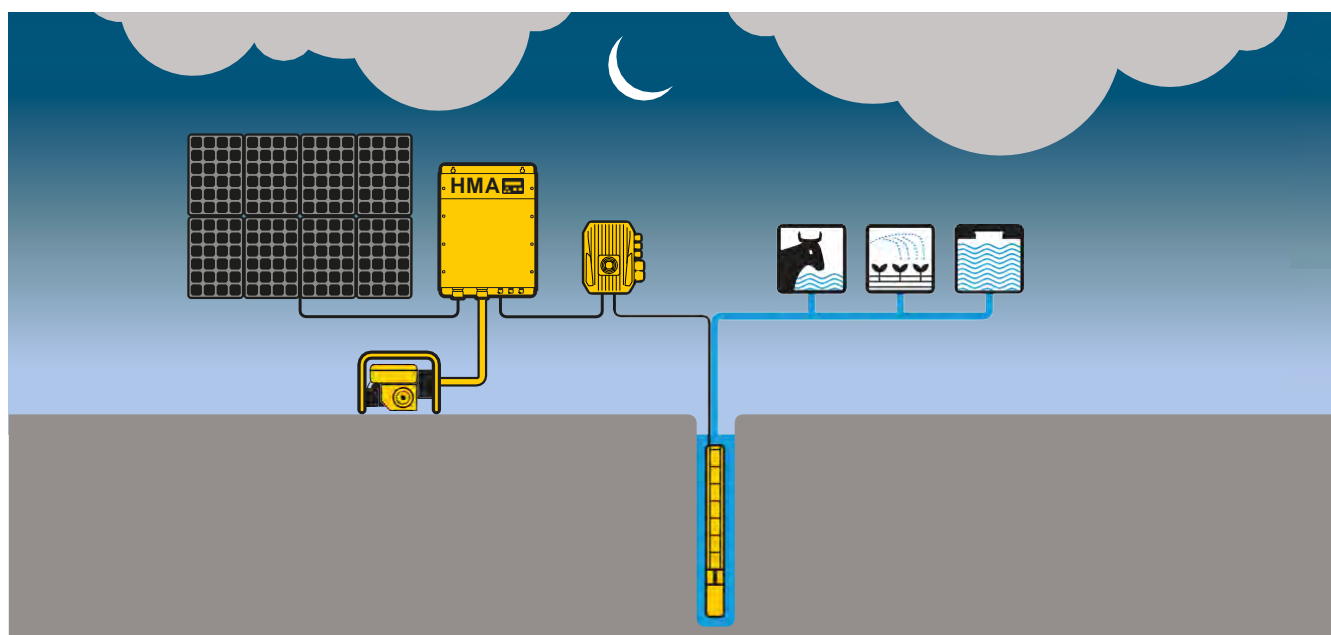

Automatic voltage adjustment

MIDA Solar is equipped with an internal “boost” circuit able to increase the voltage coming from solar panels. In this way the sizing of the photovoltaic system is independent of the pump’s nominal voltage and only proportional to its power. This implies a significant saving in the number of the solar panels, compared to systems without boost.

Example:

Pump power: 0,75 kW

Motor’s nominal voltage: 3x230 VAC

Recommended photovoltaic system power: 1250 W

Without boost

In order to allow the pump to reach the maximum frequency (maximum speed) it is necessary to guarantee at least 320 VDC input thus it is necessary to install 11 panels 250 Wp, totally 2750 Wp.

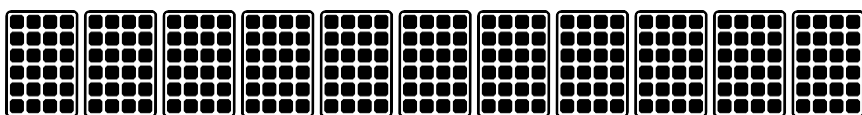

With boost

Thanks to the voltage boost integrated in MIDA Solar, only 5 panels 250 Wp are needed, with a consequent saving of 6 panels.

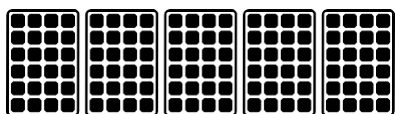

* The example considers panels 250 Wp, 30 Vmp, 37 Voc

Built-in protections against:

- Overvoltage and undervoltage.
- Overcurrent and no load.
- Dry running.
- Overtemperature.

Advanced motor controls:

- Control of single phase motors.
- Next generation control of asynchronous motors.
- Sensorless control of permanent magnet synchronous motors.

EMC compatibility for residential environment:

- Integrated PFC (P.F. 1) to meet EN61000-3-2
- Integrated input filter for Category C1 (EN61800-3), Class B (EN55011)



Unmatched user experience

Thanks to Nastec NOW App it's possible to communicate with all Nastec devices Bluetooth® SMART in order to:

- Monitor multiple operating parameters simultaneously on the wide, high definition, coloured screen of your smartphone or tablet.
- Get statistics of energy consumption and check alarms history.
- Make programs, save them in the archive, copy them to other devices and share them among multiple users.
- Perform reports with the possibility to insert notes, images and email them or keep them into the digital archive.
- Remotely control, via wi-fi or GSM, a Nastec device, using a smartphone nearby as a modem.



Alarm details

Title: UNDERVOLTAGE

Alarm: UNDERVOLTAGE

Description: Power supply voltage is lower than limit or not enough energy is available from power source. If input voltage is verified to be within limits and still UNDERVOLTAGE alarm comes out, contact technical service.

Test VS430 param8

Parameter	Value
Control mode	Constant value 2 set
Max alarm value (°C)	10.0
Min alarm value (°C)	3.5
External air passing	<input type="checkbox"/>
Test value (°C)	-1.0
Compressor (°C)	-0.5
Test value (°C)	-2.0
Compressor (set) (°C)	-0.1
Value set cooling (sec)	5
Frequency max control (Hz)	50
Stop delay (sec)	5
Control ramp (sec)	40.0
Defrost (°C)	0.5

Buttons: SAVE, COPY TO

Guide

- UNDERVOLTAGE**
Voltage supply voltage is lower than limit or too much.
- OVERVOLTAGE**
If Power supply voltage is higher than limit...
- DRY RUN COSPHI**
Motor speed is lower than the setpoint...
- OVERCURRENT MOTOR**
Motor current is higher than the rated...
- SENSOR FAULT**
Sensor reading error.
- OVER TEMPERATURE INVERTER**
Inverter over temperature.
- IGBT TRIP ALARM**
The inverter driver by the load exceeds the power...
- NO COMMUNICATION**
Communication between master and slave...

Remote

STATE: Ready

Allow to be controlled
Give the following ID to the operator, then confirm the request.

YOUR ID: 548 003 081

Control another device.
Insert here the ID provided by remote operator and send access request.

Button: CONTROL REMOTE DEVICE



Technical specifications

Model	V in DC	V in AC *	Max V out	Max I out	P2 motor power **		Size	Net Weight	Packing dimensions	Total weight
	VDC	VAC	VAC	A	VAC	kW				
MINI Solar 2.005MP	90 - 400	90 - 265	250	3,5	1 x 230 3 x 230	0,37 0,55	1	2,6	220x170x170	2,8
MINI Solar 2.011MP	90 - 400	90 - 265	250	5	1 x 230 3 x 230	0,55 1,1	1	2,6	220x170x170	2,8
MINI Solar 2.015MP	90 - 400	90 - 265	250	7,5	1 x 230 3 x 230	0,75 1,5	1	2,6	220x170x170	2,8

* AC power available only for MIDA Solar MP models.

** Typical motor power. It is recommended to refer to rated motor current when selecting the MIDA Solar model.

General specifications

- Rated frequency: 50 - 60 Hz (+/- 2%)
- Ambient temperature: -10 - 50°C (14 - 122°F)
- Max. altitude at rated current: 1000 m
- Protection degree: IP66 (NEMA 4X)
- Settable digital outputs N.O. or N.C.:
 1. Motor run signal
 2. Alarm signal
- Analog inputs (10 or 15 VDC):
 1. 4-20 mA
 2. 4-20 mA
 3. 0 - 10 VDC
 4. 0 - 10 VDC
- 4 digital inputs, configurable N.O. or N.C. for motor run/stop
- RS485 MODBUS RTU, Bluetooth® SMART* (4.0)

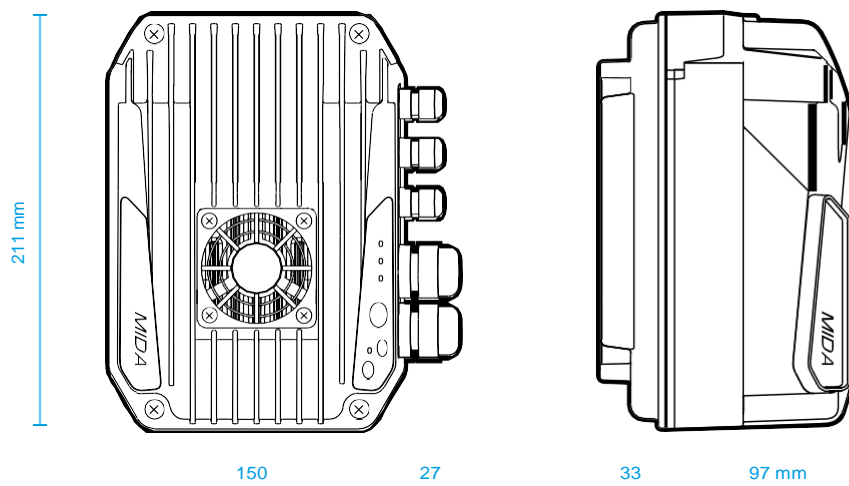

Franklin Electric (Aust) Pty Ltd
106-110 Micro Circuit
Dandenong South, Vic 3175
Tel: +61 3 9799 5000

1300 670 060
franklinwater.com.au



Franklin Electric



Franklin Electric